

| | | |
|------------|--------------|---|
| DTC | P0134 | Oxygen (A/F) Sensor Circuit No Activity Detected (Bank 1 Sensor 1) |
|------------|--------------|---|

CIRCUIT DESCRIPTION

Refer to DTC P2195 on page [DI-185](#).

HINT:

This DTC is related to A/F sensor, although the caption is oxygen sensor.

| DTC No. | DTC Detection Condition | Trouble Area |
|---------|--|--|
| P0134 | <p>After engine is warmed up, A/F sensor output* does not change when conditions (a), (b), (c) and (d) continue for at least 1.5 min.:</p> <p>*: Output value changes at inside of ECM only</p> <p>(a) Engine speed: 1,500 rpm or more</p> <p>(b) Vehicle speed: 40 – 130 km/h (25 – 81 mph)</p> <p>(c) Throttle valve is not fully closed</p> <p>(d) After starting engine \geq 140 sec.</p> | <ul style="list-style-type: none"> • Open or short in A/F sensor (bank 1 sensor 1) circuit • A/F sensor (bank 1 sensor 1) • A/F sensor heater • EFI main relay • A/F sensor heater and relay circuit • Air induction system • Fuel pressure • Injector • Gas leak in exhaust system • PCV hose connection • PCV valve and hose • ECM |

HINT:

- Sensor 1 refers to the sensor closest to the engine body.
- Sensor 2 refers to the sensor farthest from the engine body.
- After confirming DTC P0134, use the OBD II scan tool or the hand-held tester to confirm output voltage of the A/F sensor (bank 1 sensor 1) from the "DIAGNOSIS/ENHANCED OBD II/DATA LIST/ALL".
- The ECM controls the voltage of AF1+ and AF1- terminals of the ECM to the fixed voltage. Therefore it is impossible to confirm the A/F sensor output voltage without the OBD II scan tool or the hand-held tester.
- OBD II scan tool (excluding hand-held tester) displays the one fifth of the A/F sensor output voltage which is displayed on the hand-held tester.

WIRING DIAGRAM

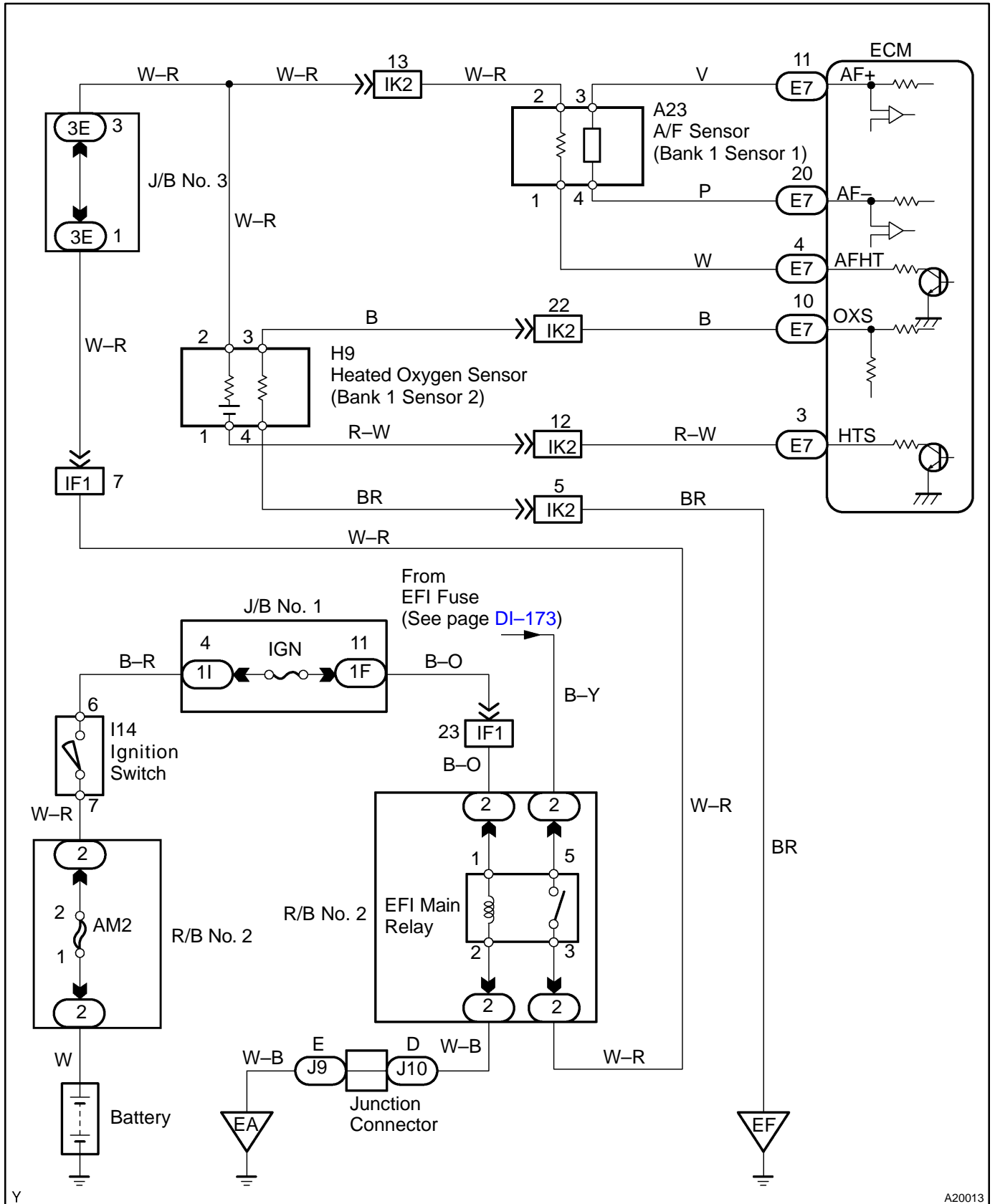

Y

A20013

CONFIRMATION DRIVING PATTERN

Refer to DTC P2195 on page [DI-185](#).

INSPECTION PROCEDURE

HINT:

Hand-held tester only:

The narrowing down the trouble area is possible by performing ACTIVE TEST of the following "A/F CONTROL" (A/F sensor, heated oxygen sensor or another can be distinguished).

Perform ACTIVE TEST by hand-held tester (A/F CONTROL).

HINT:

"A/F CONTROL" is an ACTIVE TEST which change the injection volume to -12.5 % or +25 %.

- (1) Connect the hand-held tester to the DLC3 on the vehicle.
- (2) Turn the ignition switch ON.
- (3) Warm up the engine with the engine speed at 2,500 rpm for approx. 90 sec.
- (4) Select the item "DIAGNOSIS/ENHANCED OBD II/ACTIVE TEST/ A/F CONTROL".
- (5) Perform "A/F CONTROL" when idle condition (press the ← or → button).

Result:

A/F sensor reacts in synchronizing with increase and decrease of injection volume







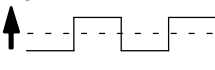
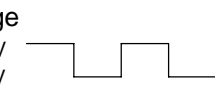
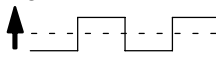
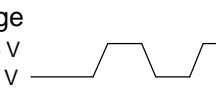
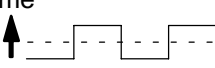

(+25 % → rich output: Less than 3.0 V, -12.5 % → lean output: More than 3.35 V)

Heated oxygen sensor reacts in synchronizing with increase and decrease of injection volume

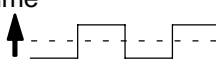
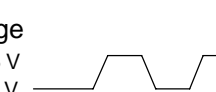
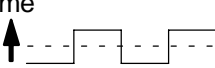
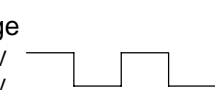
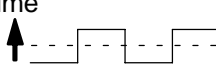
(+25 % → rich output: More than 0.55 V, -12.5 % → lean output: Less than 0.4 V)

NOTICE:

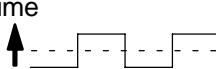
However, there is a few second delay in the A/F sensor output. And there is about 20 seconds delay in the heated oxygen sensor.

| | Output voltage of A/F sensor (sensor 1) | Output voltage of heated oxygen sensor (sensor 2) | Mainly suspect trouble area |
|--------|---|---|---|
| Case 1 | Injection volume +25 % ↑ -12.5 %  Output voltage More than 3.35 V Less than 3.0 V  OK | Injection volume +25 % ↑ -12.5 %  Output voltage More than 0.55 V Less than 0.4 V  OK | — |
| Case 2 | Injection volume +25 % ↑ -12.5 %  Output voltage No reaction  NG | Injection volume +25 % ↑ -12.5 %  Output voltage More than 0.55 V Less than 0.4 V  OK | A/F sensor (A/F sensor, heater, A/F sensor circuit) |
| Case 3 | Injection volume +25 % ↑ -12.5 %  Output voltage More than 3.35 V Less than 3.0 V  OK | Injection volume +25 % ↑ -12.5 %  Output voltage No reaction  NG | Heated oxygen sensor (heated oxygen sensor, heater, heated oxygen sensor circuit) |
| Case 4 | Injection volume +25 % ↑ -12.5 %  Output voltage No reaction  NG | Injection volume +25 % ↑ -12.5 %  Output voltage No reaction  NG | Extremely rich or lean of the actual air-fuel ratio (Injector, fuel pressure, gas leakage in exhaust system, etc) |

The following procedure of A/F CONTROL enable that to check its output (show its graph indication) of A/F sensor and heated oxygen sensor.

To display the graph indication. Select and push the "YES or NO" button 2 data "AFS B1S1 and O2S B1S2" or "AFS B2S1 and O2S B2S2" and press button "4" after selecting "ACTIVE TEST/ A/F CONTROL/USER DATA".

HINT:

- If the vehicle runs out of fuel, the air-fuel ratio is LEAN and DTC P0134 is recorded. The MIL then comes on.
- A low A/F sensor voltage could be caused by a rich air fuel mixture. Check for conditions that would cause the engine to run rich.
- A high A/F sensor voltage could be caused by a lean air fuel mixture. Check for conditions that would cause the engine to run lean.
- Read freeze frame data using the hand-held tester or the OBD II scan tool, as freeze frame data records the engine conditions when a malfunction is detected. When troubleshooting, it is useful for determining whether the vehicle was running or stopped, the engine was warmed up or not, the air-fuel ratio was lean or rich, etc. at the time of the malfunction.

| | |
|----------|--|
| 1 | Are there any other codes (besides DTC P0134) being output? |
|----------|--|

YES

Go to relevant DTC chart (See page [DI-16](#))

NO

| | |
|----------|---|
| 2 | Connect OBD II scan tool or Hand-held tester, and read value for voltage output of A/F sensor (bank 1 sensor 1). |
|----------|---|

PREPARATION:

- (a) Connect the hand-held tester or the OBD II scan tool to the DLC 3.
- (b) Warm up the A/F sensor (bank 1 sensor 1) with the engine at 2,500 rpm for approximately 90 seconds.
- (c) Read A/F sensor voltage on the OBD II scan tool or hand-held tester.

CHECK:

- (a) Hand-held tester only:
Select the "DIAGNOSIS/ENHANCED OBD II/SNAPSHOT/MANUAL SNAPSHOT/USER DATA" mode on the hand-held tester.
- (b) Select "AFS B1 S1/ENGINE SPD" and press button "YES".
- (c) Monitor the A/F sensor voltage carefully.
- (d) Check the A/F sensor voltage under the condition as follows.
 - (1) Allow engine to idle for 30 seconds.
 - (2) Engine is racing at approx. 2,500 rpm (when engine revolution is not suddenly changed).
 - (3) Raise the engine speed to 4,000 rpm and release the accelerator pedal fully closed quickly.

OK:

Standard:

Condition (1) and (2)

Voltage change a little in the vicinity of 3.3 V (0.66 V)* (between approx. 3.1 – 3.5 V) as shown in the illustration.

Condition (3)

A/F ratio sensor voltage increase to 3.8 V (0.76 V)* or more during engine deceleration (when fuel cut) as shown in the illustration.

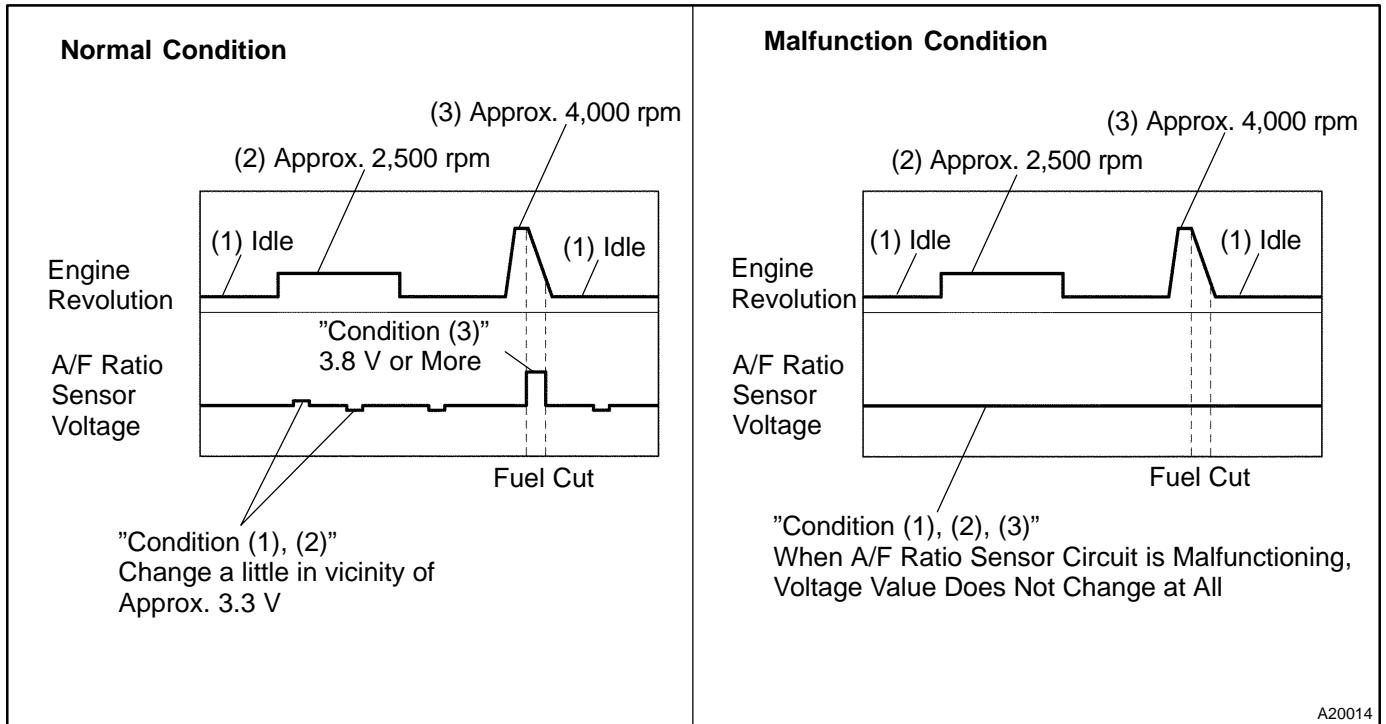

A20014

HINT:

- Whenever the output voltage of the A/F sensor remains at approx. 3.3 V (0.660 V)* (see dwg. 2) under any conditions as well as the above conditions, the A/F sensor may have an open-circuit. (This will happen also when the A/F sensor heater has an open-circuit.)
- Whenever the output voltage of the A/F sensor remains at a certain value of approx. 3.8 V (0.76 V)* or more, or 2.8 V (0.56 V)* or less (see dwg. 2) under any conditions as well as the above conditions, the A/F sensor may have a short-circuit.
- The ECM will stop fuel injection (fuel cut) during engine deceleration. This will cause a lean condition and should result in a momentary increase in A/F ratio sensor voltage.
- The ECM must establish a closed throttle position learned value to perform fuel cut. If the battery terminal has been disconnected, the vehicle must be driven over 10 mph to allow the ECM to relearn the closed throttle position.
- When the vehicle is driven:
In the case that the output voltage of the A/F sensor is below 2.8 V (0.76 V)* during fuel enrichment (for example, when the vehicle tries to overtake another vehicle on a highway, the vehicle speed is suddenly increased with the accelerator pedal fully depressed), the A/F sensor are functioning normally.
- The A/F sensor is a current output element, and therefore the current is converted into voltage inside the ECM. If measuring voltage at connectors of A/F ratio sensor or ECM, you can obtain a constant voltage.

*: When using the OBD II scan tool (excluding hand-held tester).

| | |
|-----------|-----------------------|
| OK | Go to step 16. |
|-----------|-----------------------|

NG

3 Check connection of PCV valve and hose.

NG Repair or replace PCV valve and hose

OK

4 Check resistance of A/F sensor heater (bank 1 sensor 1).

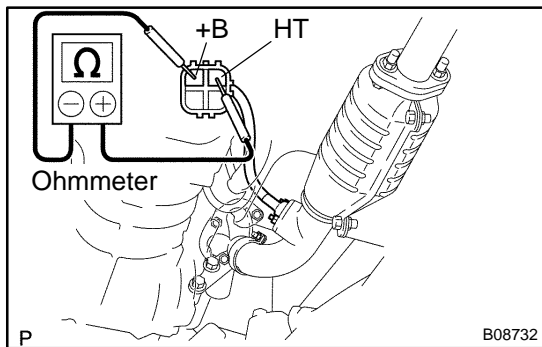

PREPARATION:

Disconnect the sensor connector.

CHECK:

Using an ohmmeter, measure the resistance between terminals +B and HT.

OK:

| | |
|--------------------|-------------|
| at 20°C (68°F) | 0.8 – 1.4 Ω |
| at 800°C (1,472°F) | 1.8 – 3.2 Ω |

NG Replace A/F sensor.

OK

5 Check EFI main relay (Marking: EFI).

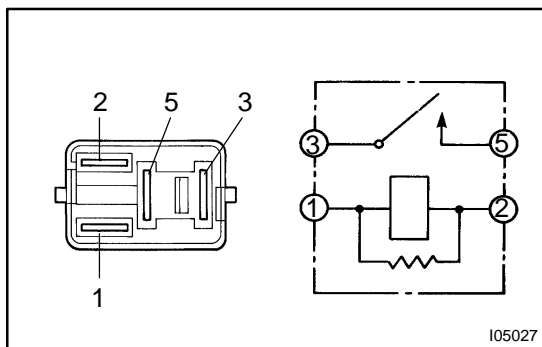

PREPARATION:

Remove the EFI main relay from RB No. 2.

CHECK:

Inspect the EFI main relay.

OK:

| Condition | Tester connection | Specified condition |
|-------------------------------------|-------------------|---------------------|
| Constant | 1 – 2 | Continuity |
| | 3 – 5 | No continuity |
| Apply B+ between terminals 1 and 2. | 3 – 5 | Continuity |

NG Replace EFI main relay.

OK

6 Check for open and short in harness and connector between ECM and A/F sensor (bank 1 sensor 1) (See page [IN-28](#)).

NG

Repair or replace harness or connector.

OK

7 Check air induction system (See page [SF-1](#)).

NG

Repair or replace.

OK

8 Only for 3RZ-FE:
Check EGR system (See page [EC-13](#)).

NG

Repair EGR system.

OK

9 Check gas leak on exhaust system.

NG

Repair or replace.

OK

10 Check fuel pressure (See page [SF-5](#)).

NG

Check and repair fuel pump, pressure regulator, fuel pipe line and filter (See page [SF-1](#)).

OK

11 Check injector injection (See page [SF-18](#)).

NG

Replace injector.

OK

12 Replace A/F sensor.

GO

13 Perform confirmation driving pattern (See page [DI-185](#)).

GO

14 Is there DTC P0134 being output again?

YES

Check and replace ECM (See page [IN-28](#)) and perform confirmation driving pattern (See page [DI-185](#)).

NO

15 Did vehicle run out of fuel in past?

NO

Check for intermittent problems (See page [DI-3](#)).

YES

DTC P0134 is caused by shortage of fuel.

| | |
|-----------|--|
| 16 | Perform confirmation driving pattern (See page DI-185). |
|-----------|--|

GO

| | |
|-----------|---|
| 17 | Is there DTC P0134 being output again? |
|-----------|---|

| | |
|-----------|-----------------------|
| NO | Go to step 21. |
|-----------|-----------------------|

YES

| | |
|-----------|----------------------------|
| 18 | Replace A/F sensor. |
|-----------|----------------------------|

GO

| | |
|-----------|--|
| 19 | Perform confirmation driving pattern (See page DI-185). |
|-----------|--|

GO

| | |
|-----------|--|
| 20 | Is there DTC P0134 being output again ? |
|-----------|--|

| | |
|------------|---|
| YES | Check and replace ECM (See page IN-28) and perform confirmation driving pattern (See page DI-185). |
|------------|---|

NO

| | |
|----|--------------------------------------|
| 21 | Did vehicle run out of fuel in past? |
|----|--------------------------------------|

NO

Check for intermittent problems
(See page [DI-3](#)).

YES

DTC P0134 is caused by shortage of fuel.