

DTC	P0441	Evaporative Emission Control System Incorrect Purge Flow
------------	--------------	---

DTC	P0446	Evaporative Emission Control System Vent Control Circuit
------------	--------------	---

CIRCUIT DESCRIPTION

The vapor pressure sensor, VSV for EVAP, VSV for canister closed valve (CCV) and VSV for pressure switching valve are used to detect abnormalities in the evaporative emission control system.

The ECM decides whether there is an abnormality in the evaporative emission control system based on the vapor pressure sensor signal.

DTCs P0441 and P0446 are recorded by the ECM when there is a malfunction in either the VSV for EVAP, the VSV for pressure switching valve, or in the vapor pressure sensor itself, or when evaporative emissions leak from the components within the dotted line in Fig. 1 below.

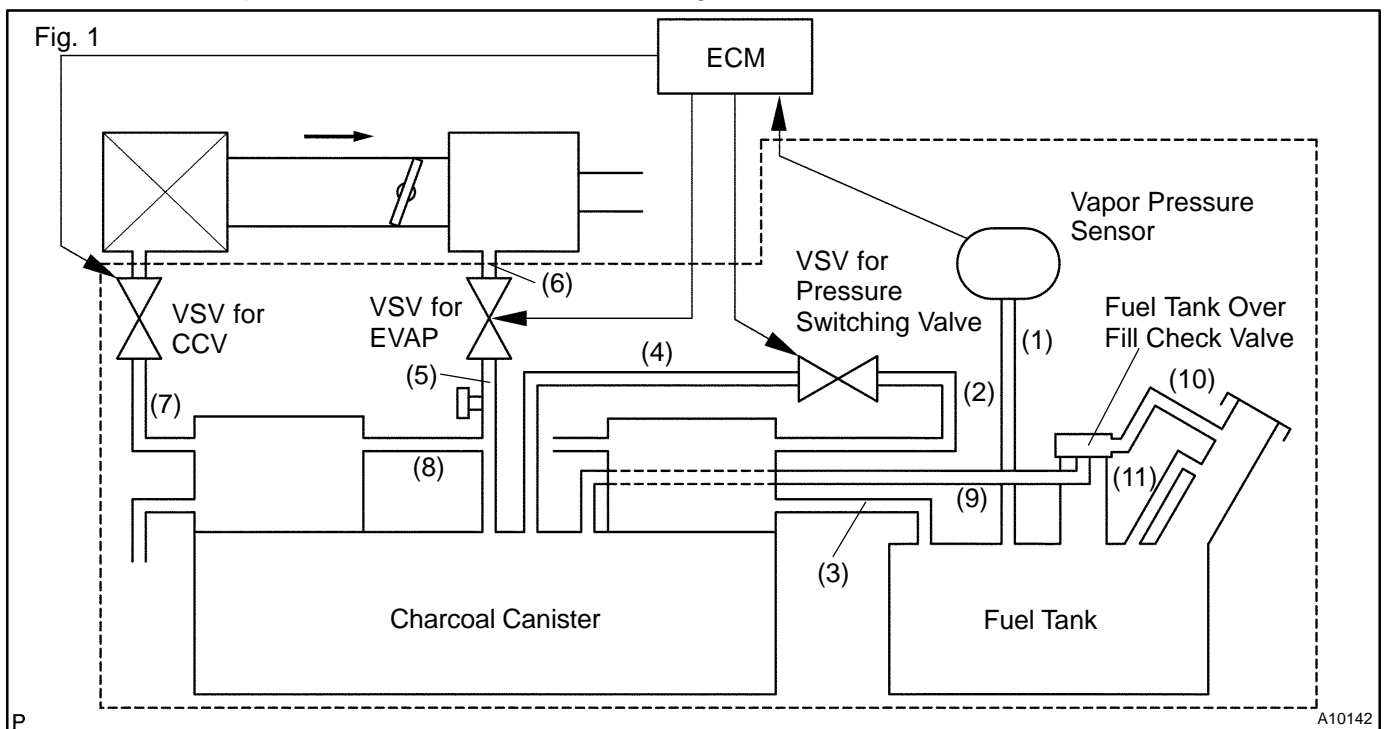

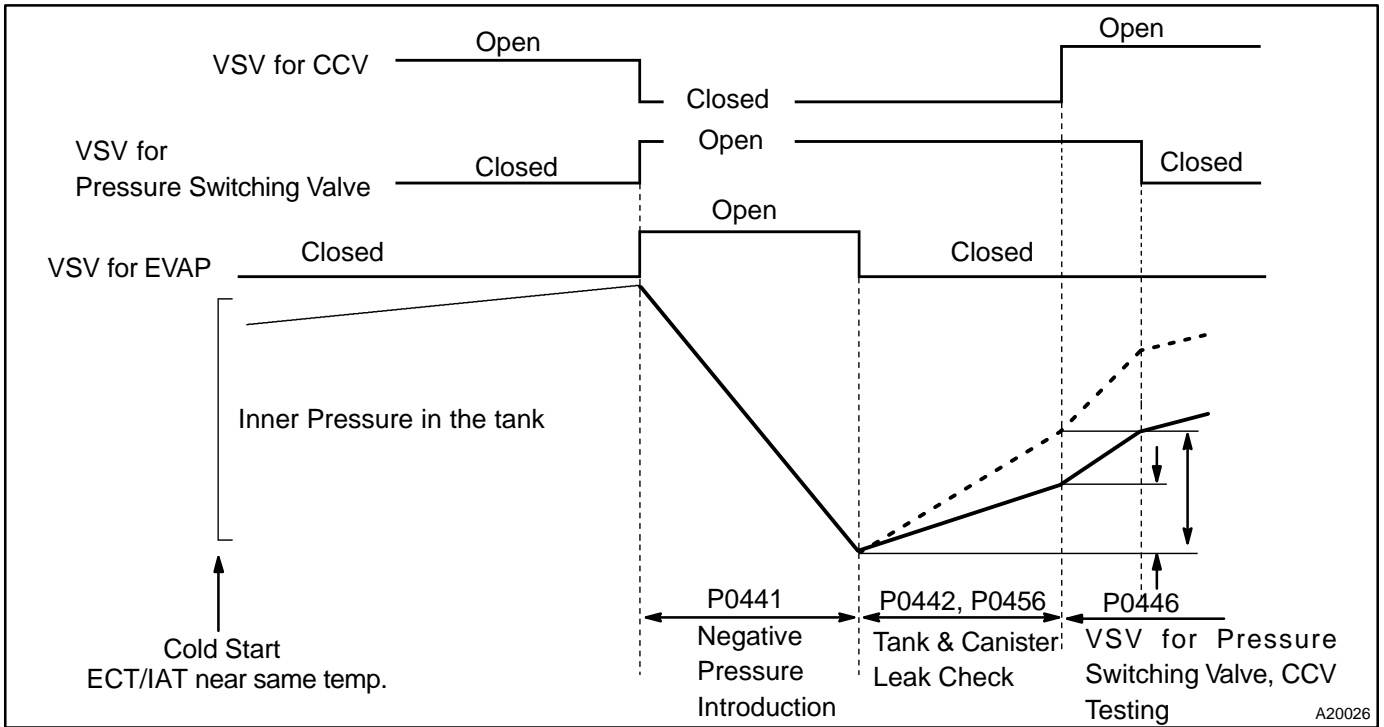

P0441

The ECM closes the CCV and opens the VSV for pressure switching valve causing vacuum to increase in the entire EVAP system.

The ECM continues to operate the VSV for EVAP until the vacuum is increased to a specified point at which time the ECM closes the VSV for EVAP.

If the vacuum did not increase, or if the vacuum increased beyond the specified limit, the ECM judges the VSV for EVAP and related components to be faulty.

P0446

When the vapor pressure rises to a specified point, the ECM opens the VSV for CCV. Pressure will increase rapidly because of the air allowed into the system. No increase or an increase below specified rate of pressure increase indicates a restriction on the air inlet side.

The ECM closes the VSV for pressure switching valve. This action blocks air entering the fuel tank side of system. The pressure rise on the fuel tank side is no longer as great.

If there was no change in pressure, the ECM will conclude the VSV for pressure switching valve did not close.

DTC No.	DTC Detecting Condition	Trouble Area
P0441	Pressure in charcoal canister and fuel tank does not drop during purge control (2 trip detection logic)	<ul style="list-style-type: none"> • Fuel tank cap incorrectly installed • Fuel tank cap cracked or damaged • Vacuum hose cracks, holed blocked, damaged or disconnected ((1), (2), (3), (4), (5), (6), (7), (8), (9), (10) and (11) in Fig. 1)
	During purge cut-off, negative pressure incoming in the charcoal canister and fuel tank will not stop. (2 trip detection logic)	
P0446	When VSV for pressure switching valve is ON, ECM judges that there is no continuity between vapor pressure sensor, fuel tank and charcoal canister (2 trip detection logic)	<ul style="list-style-type: none"> • Open or short in vapor pressure sensor circuit • Vapor pressure sensor • Open or short in VSV circuit for EVAP • VSV for EVAP • Open or short in VSV circuit for CCV • VSV for CCV • Open or short in VSV circuit for pressure switching valve • VSV for pressure switching valve • Fuel tank cracked, holed or damaged • Charcoal canister cracked, holed or damaged • Fuel tank over fill check valve cracked or damaged • ECM
	When VSV for pressure switching valve is turned OFF, pressure in fuel tank is maintained at atmospheric pressure (2 trip detection logic)	
	When VSV for CCV is ON, pressure in charcoal canister and fuel tank is maintained at atmospheric pressure (2 trip detection logic)	

HINT:**Typical DTC output of each trouble part**

Trouble part		Typical DTC output (*1)
Small Leak		P0442 and/or P0456
Medium Leak (ex: Vacuum hose loose)		P0442
Large Leak (ex: Fuel tank cap loose)		P0441 and P0442 and P0446
VSV for EVAP	Open Malfunction	P0441
	Close Malfunction	P0441 and P0442 and P0446
VSV for CCV	Open Malfunction	P0441 and P0442 and P0446
	Close Malfunction	P0446
VSV for Pressure Switching	Open Malfunction	P0446
	Close Malfunction	P0441 and P0442 and P0446

*1: ECM may output some other DTC combination.

WIRING DIAGRAM

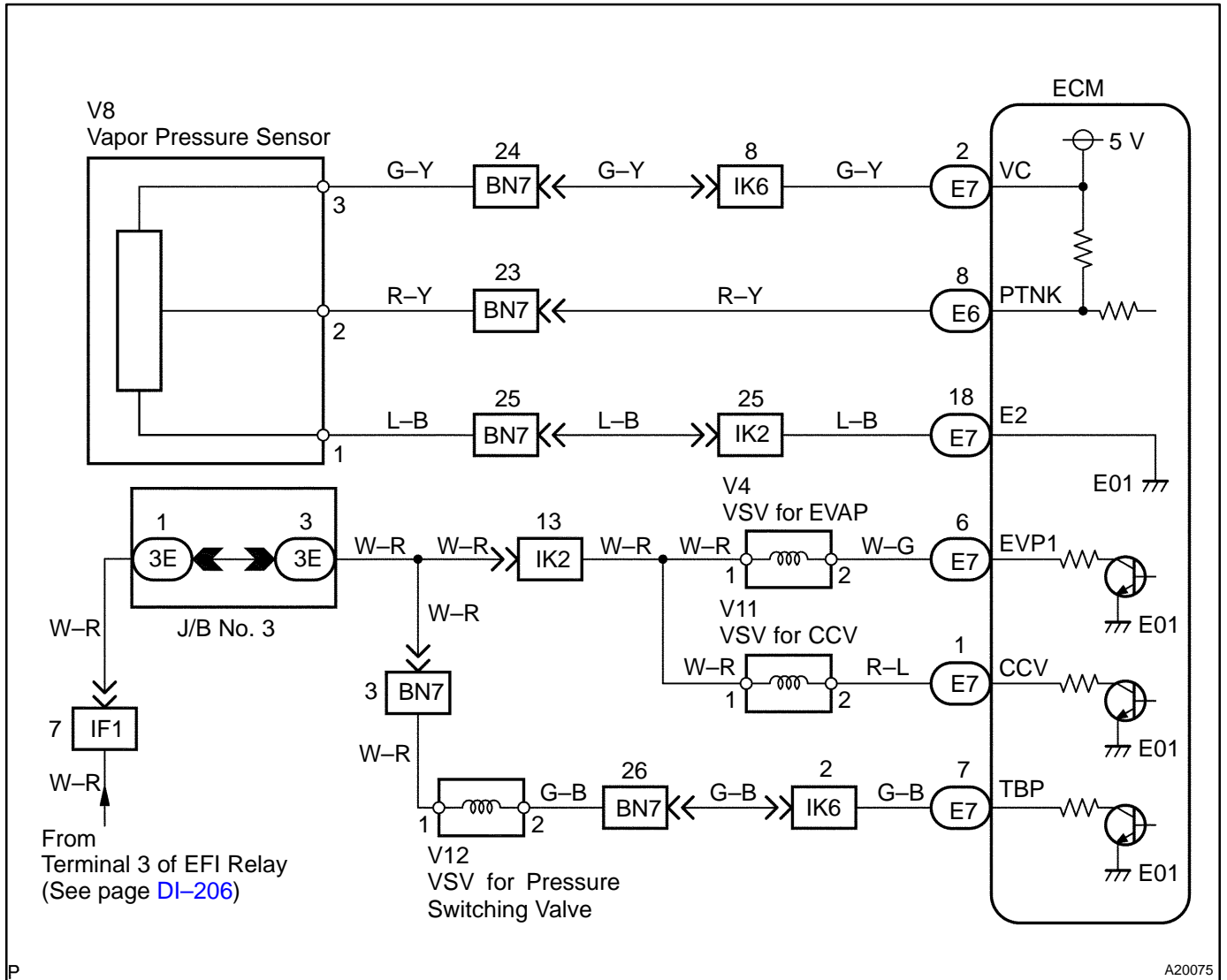

INSPECTION PROCEDURE

HINT:

- If DTC P0441 (Purge Flow), P0446 (VSV for CCV or VSV for Pressure switching valve), P0450 or P0451 (Evaporative Pressure Sensor) is output with DTC P0442 or P0456, first troubleshoot DTC P0441, P0446, P0450 or P0451. If no malfunction is detected, troubleshoot DTC P0442 or P0456 next.
- Read freeze frame data using the OBD II scan tool or the hand-held tester. Because freeze frame records the engine conditions when a malfunction is detected. When troubleshooting, it is useful for determining whether the vehicle was running or stopped, the engine was warmed up or not, the air-fuel ratio was lean or rich, etc. at the time of the malfunction.
- When the ENGINE RUN TIME in the freeze frame data is less than 200 seconds, carefully check the vapor pressure sensor.

Hand-held tester:

1	Perform EVAP leak test.
----------	--------------------------------

PREPARATION:

- (a) Connect the hand-held tester to the DLC3.
- (b) Select the item "DIAGNOSIS/ENHANCED OBD II/SYSTEM CHECK/EVAP SYS CHECK (or EVAP LEAK TEST)" mode on the hand-held tester.
- (c) Perform "EVAP SYS CHECK (or EVAP LEAK TEST)".

CHECK:

Display on the Hand-held tester	Proceed to
Scan tool detects a leak on the fuel tank side.	A
Scan tool detects a leak on the canister side.	B
Scan tool doesn't detect a leak on the EVAP system.	C

If any changes do not occur within 1 minute after pressing "EVAP LEAK TEST", once remove the fuel tank cap, then set the fuel tank cap again. Then perform the "EVAP LEAK TEST".

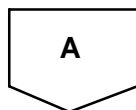
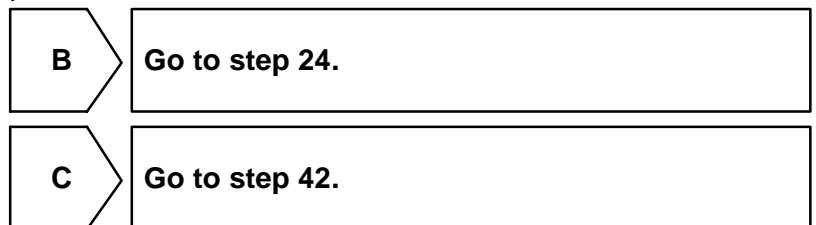

2	Check that fuel tank cap is TOYOTA genuine parts.
----------	--

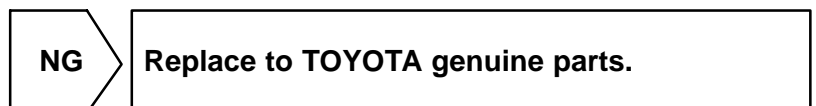

3	Check that fuel tank cap is correctly installed.
----------	---

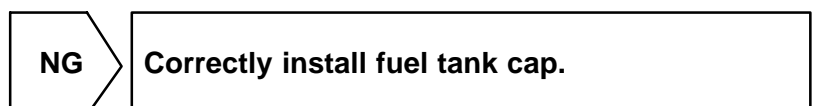

4 Check fuel tank cap (See page EC-8).

NG Replace fuel tank cap.

OK

5 Check filler neck for damage.

PREPARATION:

Remove the fuel tank cap.

CHECK:

Visually inspect the filler neck for damage.

NG Replace filler pipe.

OK

6 Check purge flow.

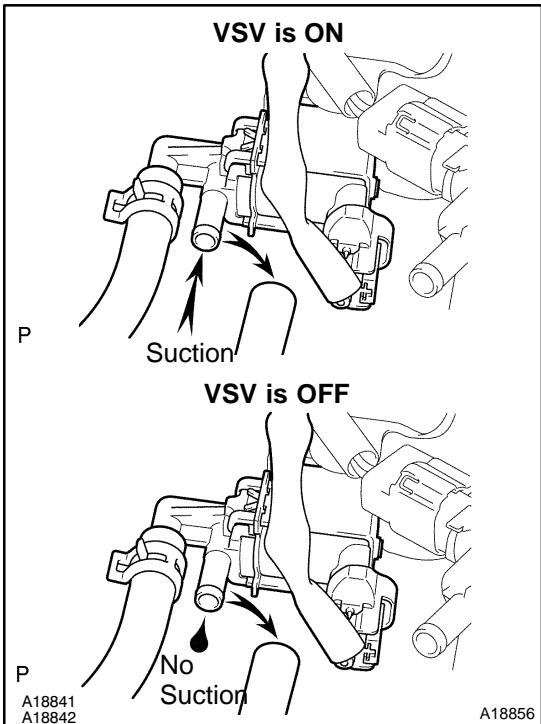

PREPARATION:

- (a) Connect the hand-held tester to the DLC3.
- (b) Select the item "DIAGNOSIS/ENHANCED OBD II/ACTIVE TEST" mode on the hand-held tester.
- (c) Disconnect the vacuum hose for the VSV for the EVAP from the charcoal canister.
- (d) Start the engine.
- (e) Select the item "EVAP VSV (ALON)/ALL" in the ACTIVE TEST and operate EVAP VSV (Press the ← or → button).

CHECK:

When the VSV for the EVAP is operated by the hand-held tester, check whether the disconnected hose applies suction to your finger.

OK:

- VSV is ON:**
Disconnected hose applies suction to your finger.
- VSV is OFF:**
Disconnected hose applies no suction to your finger.

OK

Go to step 10.

NG

7

Check vacuum hose between intake manifold and VSV for EVAP, and VSV for EVAP and charcoal canister.

CHECK:

- (a) Check that the vacuum hose is connected correctly.
- (b) Check the vacuum hose for looseness and disconnection.
- (c) Check the vacuum hose for cracks, hole, damage and blockage.

NG

Repair or replace.

OK

8

Check operation of VSV for EVAP (See page [SF-43](#)).

NG

Replace VSV for EVAP.

OK

9

Check for open and short in harness and connector between EFI main relay (Marking: EFI) and VSV for EVAP, and VSV for EVAP and ECM (See page [IN-28](#)).

NG

Repair or replace harness or connector.

OK

Check and replace ECM (See page [IN-28](#)).

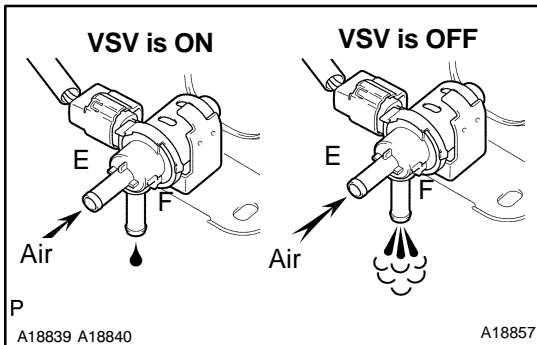
10 Check VSV for CCV.**PREPARATION:**

- Disconnect the vacuum hose for the VSV for the CCV from the charcoal canister.
- Turn the ignition switch ON and push the hand-held tester main switch ON.
- Select the item "DIAGNOSIS/ENHANCED OBD II/ACTIVE TEST" mode on the hand-held tester.
- Select the item "INTAKE CTL VSV/ALL" in the ACTIVE TEST and operate INTAKE CTL VSV (Press the ← or → button).

CHECK:

Check the VSV operation when it is operated by the hand-held tester.

OK:

VSV is ON:

Air does not flow from port E to port F.

VSV is OFF:

Air from port E flows out through port F.

OK

Go to step 14.

NG

11 Check vacuum hose between VSV for CCV and charcoal canister.**CHECK:**

- Check that the vacuum hose is connected correctly.
- Check the vacuum hose for looseness and disconnection.
- Check the vacuum hose for cracks, hole damage, and blockage.

NG

Repair or replace.

OK

12 Check operation of VSV for CCV (See page SF-44).

NG

Replace VSV for CCV.

OK

- 13** Check for open and short in harness and connector between EFI main relay (Marking: EFI) and VSV for CCV, and VSV for CCV and ECM (See page [IN-28](#)).

NG

Repair or replace harness or connector.

OK

Check and replace ECM (See page [IN-28](#)).

- 14** Check VSV for pressure switching valve.

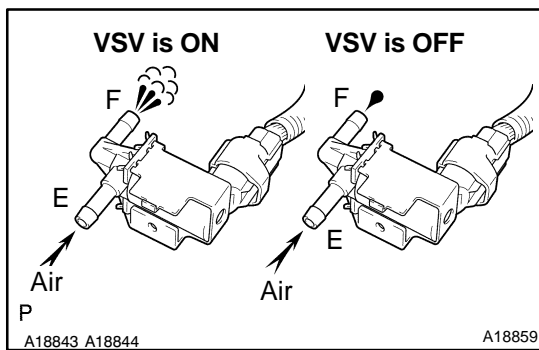

PREPARATION:

- Turn the ignition switch ON and push the hand-held tester main switch ON.
- Select the item "DIAGNOSIS/ENHANCED OBD II/ACTIVE TEST" mode on the hand-held tester.
- Select the item "TANK BYPASS VSV/ALL" in the ACTIVE TEST and operate TANK BYPASS VSV (Press the ← or → button).

CHECK:

Check the VSV operation when it is operated by the hand-held tester.

OK:

VSV is ON:

Air from port E flows out through port F.

VSV is OFF:

Air does not flow from port E to port F.

OK

Go to step 17.

NG

- 15** Check operation of VSV for pressure switching valve (See page [SF-46](#)).

NG

Replace VSV for pressure switching valve.

OK

- 16** Check for open and short in harness and connector between EFI main relay (Marking: EFI) and VSV for pressure switching valve, and VSV for pressure switching valve and ECM (See page [IN-28](#)).

NG

Repair or replace harness or connector.

OK

Check and replace ECM (See page [IN-28](#)).

- 17** Check whether hose close to fuel tank have been modified, and check whether there are signs of any accident near fuel tank.

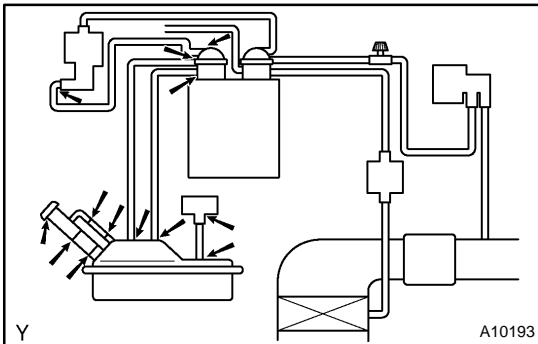
**CHECK:**

Check for cracks, deformation and loose connection of the following parts:

- Fuel tank
- Fuel tank filler pipe
- Hoses and tubes around fuel tank

NG

Repair or replace.

OK

- 18** Check vacuum hoses between vapor pressure sensor and fuel tank, and charcoal canister and VSV for pressure switching valve.

CHECK:

- (a) Check that the vacuum hose is connected correctly.
- (b) Check the vacuum hose for looseness and disconnection.
- (c) Check the vacuum hose for cracks, hole and damage.

NG

Repair or replace.

OK

19	Check hose and tube between fuel tank and charcoal canister.
-----------	---

CHECK:

- (a) Check for proper connection of the fuel tank and fuel evap pipe (See page [EC-8](#)), fuel evap pipe and fuel tube under the floor, fuel tube under the floor and charcoal canister.
- (b) Check the hose and tube for cracks, hole and damage.

NG	Repair or replace.
-----------	---------------------------

OK

20	Check voltage between terminals VC and E2 of ECM connector.
-----------	--

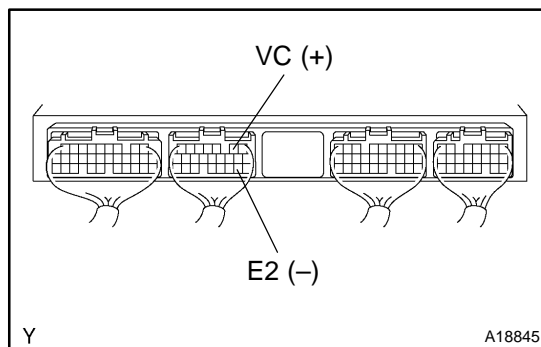
**CHECK:**

- (a) Remove the groove compartment (See page [SF-55](#)).
- (b) Turn the ignition switch ON.

CHECK:

Measure the voltage between terminals VC and E2 of the ECM connector.

OK:

Voltage: 4.5 – 5.5 V

NG	Check and replace ECM (See page IN-28).
-----------	--

OK

21 Check voltage between terminals PTNK and E2 of ECM connectors.

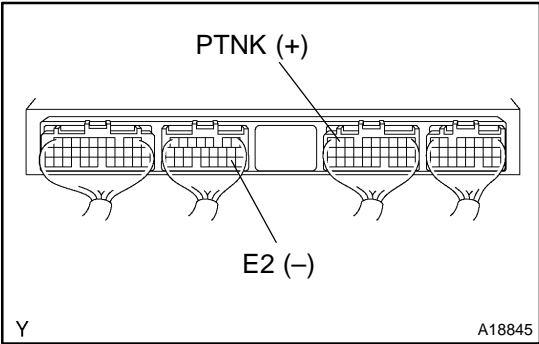

PREPARATION:

- (a) Remove the groove compartment (See page [SF-56](#)).
- (b) Turn the ignition switch ON.

CHECK:

Measure the voltage between terminals PTNK and E2 of the ECM connectors.

- (1) Disconnect the vacuum hose from the vapor pressure sensor.
- (2) Using the MITYVAC (Hand-held Vacuum Pump), apply a vacuum of 4.0 kPa (30 mmHg, 1.18 in.Hg) to the vapor pressure sensor.

NOTICE:

The vacuum applied to the vapor pressure sensor must be less than 66.7 kPa (500 mmHg, 19.7 in.Hg).

OK:

- (1) Voltage: 2.9 – 3.7 V
- (2) Voltage: 0.5 V or less

OK → Go to step 23.

NG

22 Check for open and short in harness and connector between vapor pressure sensor and ECM (See page [IN-28](#)).

NG → Repair or replace harness or connector.

OK

Replace vapor pressure sensor.

23 Check fuel tank over fill check valve for cracks and damage.

NG

Replace fuel tank over fill check valve.

OK

Check and replace fuel tank.

24 Check purge flow.

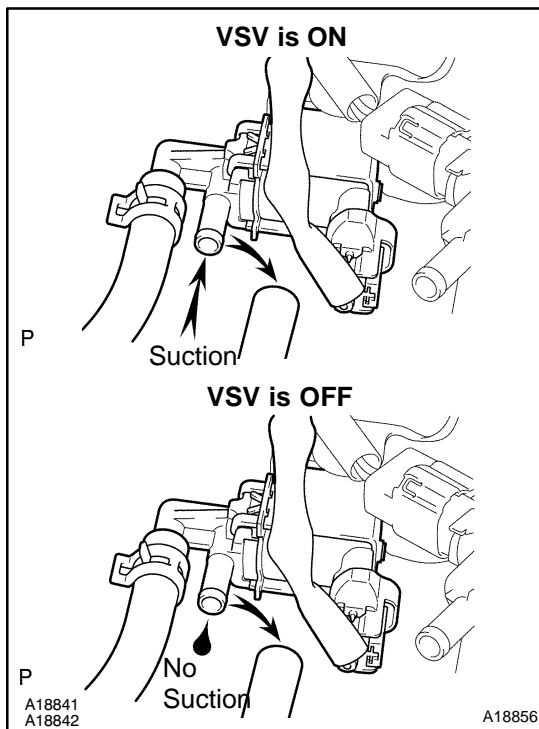

PREPARATION:

- Connect the hand-held tester to the DLC3.
- Select the item "DIAGNOSIS/ENHANCED OBD II/ACTIVE TEST" mode on the hand-held tester.
- Disconnect the vacuum hose for the VSV for the EVAP from the charcoal canister.
- Start the engine.
- Select the item "EVAP VSV (ALON)/ALL" in the ACTIVE TEST and operate EVAP VSV (Press the ← or → button).

CHECK:

When the VSV for the EVAP is operated by the hand-held tester, check whether the disconnected hose applies suction to your finger.

OK:

VSV is ON:

Disconnected hose applies suction to your finger.

VSV is OFF:

Disconnected hose applies no suction to your finger.

OK

Go to step 28.

NG

25	Check vacuum hose between intake manifold and VSV for EVAP, and VSV for EVAP and charcoal canister.
-----------	--

CHECK:

- (a) Check that the vacuum hose is connected correctly.
- (b) Check the vacuum hose for looseness and disconnection.
- (c) Check the vacuum hose for cracks, hole, damage and blockage.

NG	Repair or replace.
-----------	---------------------------

OK

26	Check operation of VSV for EVAP (See page SF-43).
-----------	--

NG	Replace VSV for EVAP.
-----------	------------------------------

OK

27	Check for open and short in harness and connector between EFI main relay (Marking: EFI) and VSV for EVAP, and VSV for EVAP and ECM (See page IN-28).
-----------	---

NG	Repair or replace harness or connector.
-----------	--

OK

Check and replace ECM (See page IN-28).
--

28	Check VSV for CCV.
-----------	---------------------------

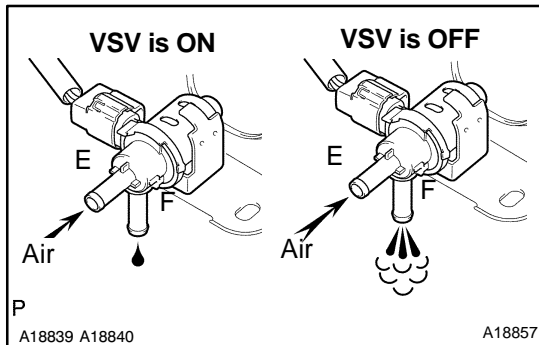
**PREPARATION:**

- (a) Disconnect the vacuum hose for the VSV for the CCV from the charcoal canister.
- (b) Turn the ignition switch ON and push the hand-held tester main switch ON.
- (c) Select the item "DIAGNOSIS/ENHANCED OBD II/ACTIVE TEST" mode on the hand-held tester.
- (d) Select the item "INTAKE CTL VSV/ALL" in the ACTIVE TEST and operate INTAKE CTL VSV (Press the ← or → button).

CHECK:

Check the VSV operation when it is operated by the hand-held tester.

OK:

VSV is ON:

Air does not flow from port E to port F.

VSV is OFF:

Air from port E flows out through port F.

OK	Go to step 32.
-----------	-----------------------

NG

29	Check vacuum hose between VSV for CCV and charcoal canister.
-----------	---

CHECK:

- (a) Check that the vacuum hose is connected correctly.
- (b) Check the vacuum hose for looseness and disconnection.
- (c) Check the vacuum hose for cracks, hole damage, and blockage.

NG	Repair or replace.
-----------	---------------------------

OK

30	Check operation of VSV for CCV (See page SF-44).
-----------	---

NG	Replace VSV for CCV.
-----------	-----------------------------

OK

31 Check for open and short in harness and connector between EFI main relay (Marking: EFI) and VSV for CCV, and VSV for CCV and ECM (See page [IN-28](#)).

NG

Repair or replace harness or connector.

OK

Check and replace ECM (See page [IN-28](#)).

32 Check VSV for pressure switching valve.

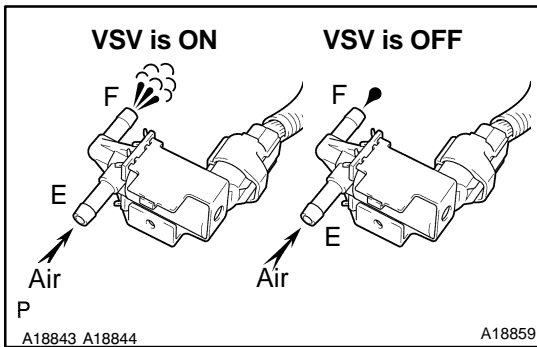

PREPARATION:

- Turn the ignition switch ON and push the hand-held tester main switch ON.
- Select the item "DIAGNOSIS/ENHANCED OBD II/ACTIVE TEST" mode on the hand-held tester.
- Select the item "TANK BYPASS VSV/ALL" in the ACTIVE TEST and operate TANK BYPASS VSV (Press the ← or → button).

CHECK:

Check the VSV operation when it is operated by the hand-held tester.

OK:

VSV is ON:

Air from port E flows out through port F.

VSV is OFF:

Air does not flow from port E to port F.

OK

Go to step 35.

NG

33 Check operation of VSV for pressure switching valve (See page [SF-46](#)).

NG

Replace VSV for pressure switching valve.

OK

- 34** Check for open and short in harness and connector between EFI main relay (Marking: EFI) and VSV for pressure switching valve, and VSV for pressure switching valve and ECM (See page [IN-28](#)).

NG

Repair or replace harness or connector.

OK

Check and replace ECM (See page [IN-28](#)).

- 35** Check whether there are signs of any accident near charcoal canister.

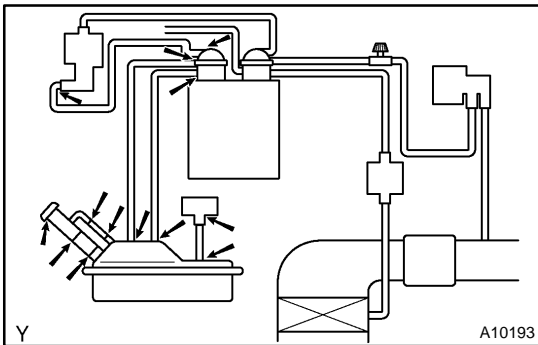
**CHECK:**

Check for cracks, deformation and loose connection of the following parts:

- Charcoal canister
- Hoses and tubes around charcoal canister

NG

Repair or replace.

OK

- 36** Check vacuum hoses ((4), (5), (7) and (8) in Fig. 1 in description).

CHECK:

- Check that the vacuum hose is connected correctly.
- Check the vacuum hose for looseness and disconnection.
- Check the vacuum hose for cracks, hole and damage.

NG

Repair or replace.

OK

37 Check hose and tube between fuel tank and charcoal canister.

CHECK:

- (a) Check for proper connection of the fuel tank and fuel evap pipe (See page EC-8), fuel evap pipe and fuel tube under the floor, fuel tube under the floor and charcoal canister.
- (b) Check the hose and tube for cracks, hole and damage.

NG Repair or replace.

OK

38 Check charcoal canister for cracks, hole and damage (See page EC-8).

NG Repair or replace.

OK

39 Check voltage between terminals VC and E2 of ECM connector.

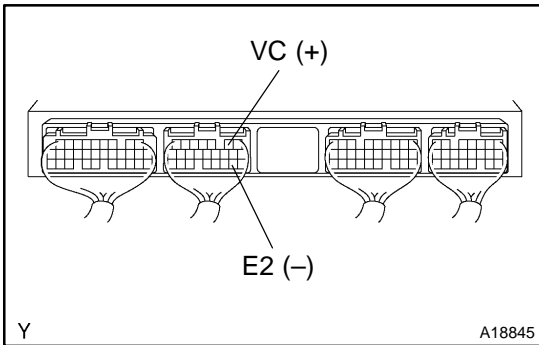

CHECK:

- (a) Remove the groove compartment (See page SF-55).
- (b) Turn the ignition switch ON.

CHECK:

Measure the voltage between terminals VC and E2 of the ECM connector.

OK:

Voltage: 4.5 – 5.5 V

NG Check and replace ECM (See page IN-28).

OK

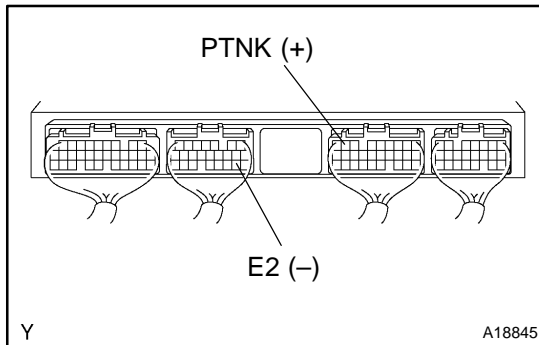
40 Check voltage between terminals PTNK and E2 of ECM connectors.**PREPARATION:**

- (a) Remove the groove compartment (See page [SF-55](#)).
- (b) Turn the ignition switch ON.

CHECK:

Measure the voltage between terminals PTNK and E2 of the ECM connectors.

- (1) Disconnect the vacuum hose from the vapor pressure sensor.
- (2) Using the MITYVAC (Hand-held Vacuum Pump), apply a vacuum of 4.0 kPa (30 mmHg, 1.18 in.Hg) to the vapor pressure sensor.

NOTICE:

The vacuum applied to the vapor pressure sensor must be less than 66.7 kPa (500 mmHg, 19.7 in.Hg).

OK:

- (1) Voltage: 2.9 – 3.7 V
- (2) Voltage: 0.5 V or less

OK

Check and replace ECM (See page [IN-28](#)).

NG

41 Check for open and short in harness and connector between vapor pressure sensor and ECM (See page [IN-28](#)).

NG

Repair or replace harness or connector.

OK

Replace vapor pressure sensor.

42 Check purge flow.

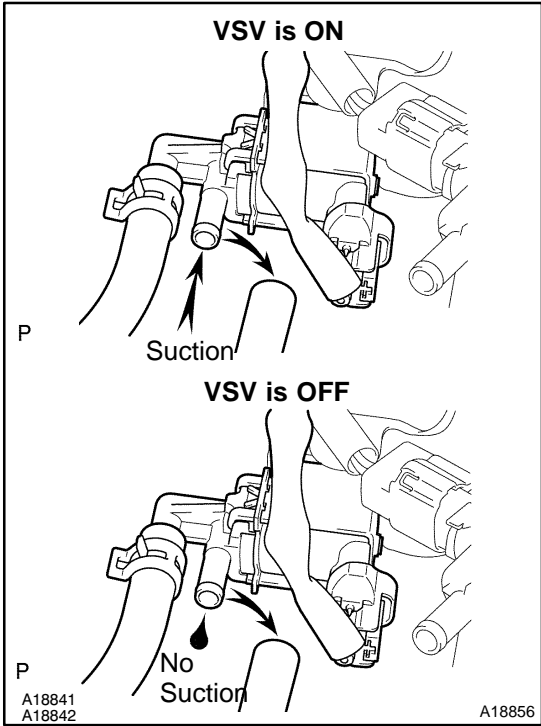

PREPARATION:

- (a) Connect the hand-held tester to the DLC3.
- (b) Select the item "DIAGNOSIS/ENHANCED OBD II/ACTIVE TEST" mode on the hand-held tester.
- (c) Disconnect the vacuum hose for the VSV for the EVAP from the charcoal canister.
- (d) Start the engine.
- (e) Select the item "EVAP VSV (ALON)/ALL" in the ACTIVE TEST and operate EVAP VSV (Press the ← or → button).

CHECK:

When the VSV for the EVAP is operated by the hand-held tester, check whether the disconnected hose applies suction to your finger.

OK:

VSV is ON:

Disconnected hose applies suction to your finger.

VSV is OFF:

Disconnected hose applies no suction to your finger.

OK → Go to step 46.

NG

43 Check vacuum hose between intake manifold and VSV for EVAP, and VSV for EVAP and charcoal canister.

CHECK:

- (a) Check that the vacuum hose is connected correctly.
- (b) Check the vacuum hose for looseness and disconnection.
- (c) Check the vacuum hose for cracks, hole, damage and blockage.

NG → Repair or replace.

OK

44 Check operation of VSV for EVAP (See page SF-43).

NG → Replace VSV for EVAP.

OK

- | | |
|-----------|---|
| 45 | Check for open and short in harness and connector between EFI main relay (Marking: EFI) and VSV for EVAP, and VSV for EVAP and ECM (See page IN-28). |
|-----------|---|

NG

Repair or replace harness or connector.

OK

Check and replace ECM (See page IN-28).

- | | |
|-----------|---------------------------|
| 46 | Check VSV for CCV. |
|-----------|---------------------------|

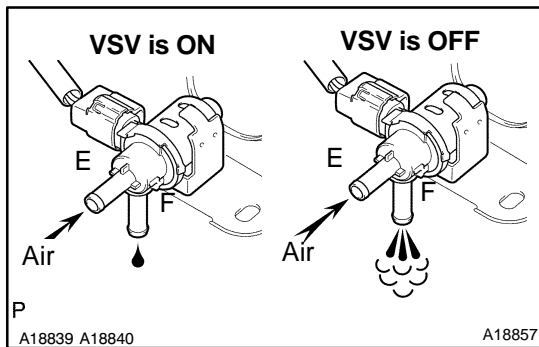
**PREPARATION:**

- Disconnect the vacuum hose for the VSV for the CCV from the charcoal canister.
- Turn the ignition switch ON and push the hand-held tester main switch ON.
- Select the item "DIAGNOSIS/ENHANCED OBD II/ACTIVE TEST" mode on the hand-held tester.
- Select the item "INTAKE CTL VSV/ALL" in the ACTIVE TEST and operate INTAKE CTL VSV (Press the ← or → button).

CHECK:

Check the VSV operation when it is operated by the hand-held tester.

OK:**VSV is ON:**

Air does not flow from port E to port F.

VSV is OFF:

Air from port E flows out through port F.

OK

Go to step 50.

NG

47 Check vacuum hose between VSV for CCV and charcoal canister.

CHECK:

- (a) Check that the vacuum hose is connected correctly.
- (b) Check the vacuum hose for looseness and disconnection.
- (c) Check the vacuum hose for cracks, hole damage, and blockage.

NG**Repair or replace.****OK**

48 Check operation of VSV for CCV (See page [SF-44](#)).

NG**Replace VSV for CCV.****OK**

49 Check for open and short in harness and connector between EFI main relay (Marking: EFI) and VSV for CCV, and VSV for CCV and ECM (See page [IN-28](#)).

NG**Repair or replace harness or connector.****OK**

Check and replace ECM (See page [IN-28](#)).

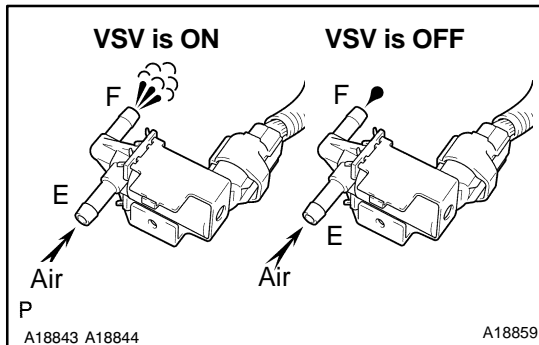
50 Check VSV for pressure switching valve.
**PREPARATION:**

- Turn the ignition switch ON and push the hand-held tester main switch ON.
- Select the item "DIAGNOSIS/ENHANCED OBD II/ACTIVE TEST" mode on the hand-held tester.
- Select the item "TANK BYPASS VSV/ALL" in the ACTIVE TEST and operate TANK BYPASS VSV (Press the ← or → button).

CHECK:

Check the VSV operation when it is operated by the hand-held tester.

OK:

VSV is ON:

Air from port E flows out through port F.

VSV is OFF:

Air does not flow from port E to port F.

OK

Go to step 53.

NG

51 Check operation of VSV for pressure switching valve (See page SF-46).

NG

Replace VSV for pressure switching valve.

OK

52 Check for open and short in harness and connector between EFI main relay (Marking: EFI) and VSV for pressure switching valve, and VSV for pressure switching valve and ECM (See page IN-28).

NG

Repair or replace harness or connector.

OK

Check and replace ECM (See page IN-28).

53 Check whether hose close to fuel tank have been modified, and check whether there are signs of any accident near fuel tank or charcoal canister.

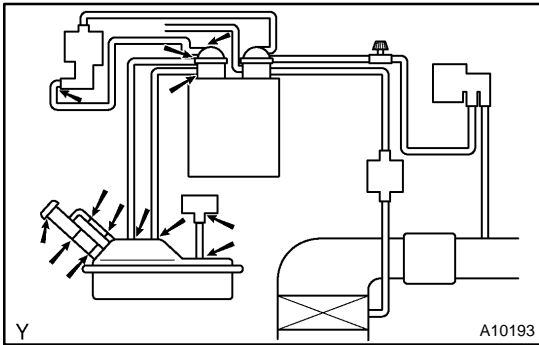
**CHECK:**

Check for cracks, deformation and loose connection of the following parts:

- Fuel tank
- Charcoal canister
- Fuel tank filler pipe
- Hoses and tubes around fuel tank and charcoal canister

NG**Repair or replace.****OK**

54 Check vacuum hoses between vapor pressure sensor and fuel tank, and charcoal canister and VSV for pressure switching valve.

CHECK:

- (a) Check that the vacuum hose is connected correctly.
- (b) Check the vacuum hose for looseness and disconnection.
- (c) Check the vacuum hose for cracks, hole and damage.

NG**Repair or replace.****OK**

55 Check vacuum hoses ((4), (5), (7) and (8) in Fig. 1 in description).

CHECK:

- (a) Check that the vacuum hose is connected correctly.
- (b) Check the vacuum hose for looseness and disconnection.
- (c) Check the vacuum hose for cracks, hole and damage.

NG**Repair or replace.****OK**

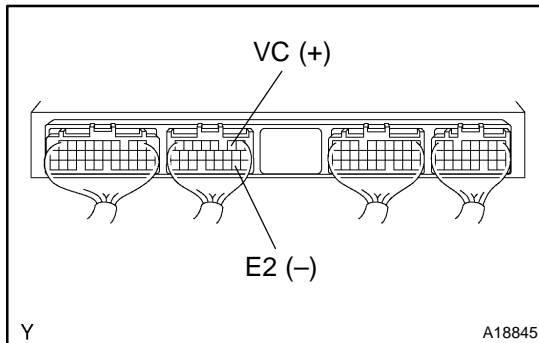
56 Check voltage between terminals VC and E2 of ECM connector.
**CHECK:**

- (a) Remove the groove compartment (See page [SF-55](#)).
- (b) Turn the ignition switch ON.

CHECK:

Measure the voltage between terminals VC and E2 of the ECM connector.

OK:

Voltage: 4.5 – 5.5 V

NG

Check and replace ECM (See page [IN-28](#)).

OK

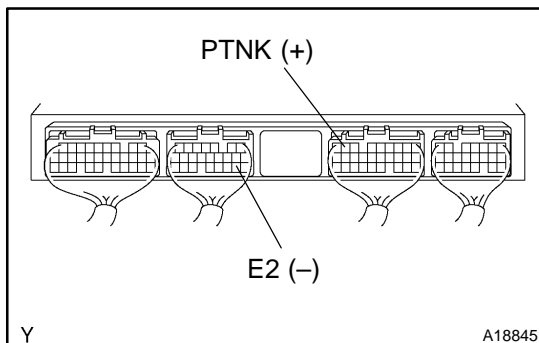
57 Check voltage between terminals PTNK and E2 of ECM connectors.
**PREPARATION:**

- (a) Remove the groove compartment (See page [SF-55](#)).
- (b) Turn the ignition switch ON.

CHECK:

Measure the voltage between terminals PTNK and E2 of the ECM connectors.

- (1) Disconnect the vacuum hose from the vapor pressure sensor.
- (2) Using the MITYVAC (Hand-held Vacuum Pump), apply a vacuum of 4.0 kPa (30 mmHg, 1.18 in.Hg) to the vapor pressure sensor.

NOTICE:

The vacuum applied to the vapor pressure sensor must be less than 66.7 kPa (500 mmHg, 19.7 in.Hg).

OK:

- (1) Voltage: 2.9 – 3.7 V
- (2) Voltage: 0.5 V or less

NG

Check and replace ECM (See page [IN-28](#)).

OK

58	Check for open and short in harness and connector between vapor pressure sensor and ECM (See page IN-28).
-----------	--

NG	Repair or replace harness or connector.
-----------	--

OK

Replace vapor pressure sensor.

OBD II scan tool (excluding hand-held tester):

1	Check that fuel tank cap is TOYOTA genuine parts.
----------	--

NG	Replace to TOYOTA genuine parts.
-----------	---

OK

2	Check that fuel tank cap is correctly installed.
----------	---

NG	Correctly install fuel tank cap.
-----------	---

OK

3	Check fuel tank cap (See page EC-8).
----------	---

NG	Replace fuel tank cap.
-----------	-------------------------------

OK

4	Check filler neck for damage.
----------	--------------------------------------

PREPARATION:

Remove the fuel tank cap.

CHECK:

Visually inspect the filler neck for damage.

NG	Replace filler pipe.
-----------	-----------------------------

OK

5	Check whether hose close to fuel tank have been modified, and check whether there are signs of any accident near fuel tank or charcoal canister.
----------	---

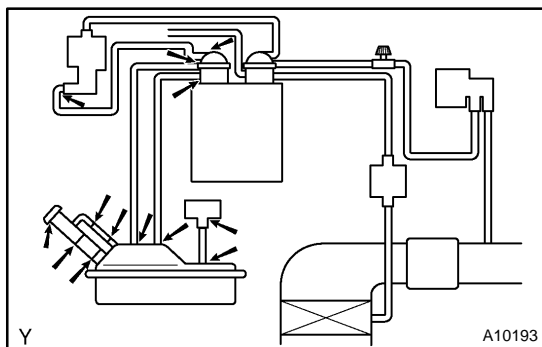
**CHECK:**

Check for cracks, deformation and loose connection of the following parts:

- Fuel tank
- Charcoal canister
- Fuel tank filler pipe
- Hoses and tubes around fuel tank and charcoal canister

NG	Repair or replace.
-----------	---------------------------

OK

6	Check vacuum hoses between vapor pressure sensor and fuel tank, charcoal canister and VSV for pressure switching valve, and VSV for pressure switching valve and charcoal canister.
----------	--

CHECK:

- (a) Check that the vacuum hose is connected correctly.
- (b) Check the vacuum hose for looseness and disconnection.
- (c) Check the vacuum hose for cracks, hole and damage.

NG	Repair or replace.
-----------	---------------------------

OK

7	Check hose and tube between fuel tank and charcoal canister.
----------	---

CHECK:

- (a) Check for proper connection of the fuel tank and fuel evap pipe (See page [EC-8](#)), fuel evap pipe and fuel tube under the floor, fuel tube under the floor and charcoal canister.
- (b) Check the hose and tube for cracks, hole and damage.

NG	Repair or replace.
-----------	---------------------------

OK

8	Check vacuum hoses ((5), (6), (7), (8) and (9) in Fig. 1 in circuit description).
----------	--

CHECK:

- (a) Check that the vacuum hose is connected correctly.
- (b) Check the vacuum hose for looseness and disconnection.
- (c) Check the vacuum hose for cracks, hole damage, and blockage.

NG	Repair or replace.
-----------	---------------------------

OK

9	Check VSV connector for EVAP, VSV connector for CCV, VSV connector for pressure switching valve and vapor pressure sensor connector for looseness and disconnection.
----------	---

NG	Repair or connect VSV or sensor connector.
-----------	---

OK

10	Check charcoal canister for cracks, hole and damage (See page EC-8).
-----------	---

NG	Replace charcoal canister.
-----------	-----------------------------------

OK

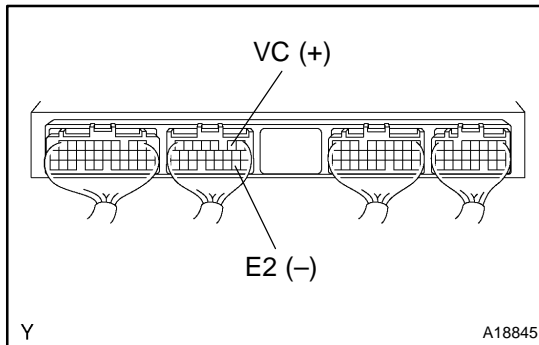
11 Check voltage between terminals VC and E2 of ECM connector.
**CHECK:**

- (a) Remove the groove compartment (See page [SF-55](#)).
- (b) Turn the ignition switch ON.

CHECK:

Measure the voltage between terminals VC and E2 of the ECM connector.

OK:

Voltage: 4.5 – 5.5 V

NG

Check and replace ECM (See page [IN-28](#)).

OK

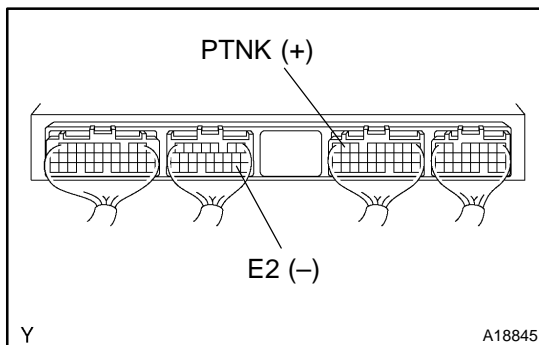
12 Check voltage between terminals PTNK and E2 of ECM connectors.
**PREPARATION:**

- (a) Remove the groove compartment (See page [SF-55](#)).
- (b) Turn the ignition switch ON.

CHECK:

Measure the voltage between terminals PTNK and E2 of the ECM connectors.

- (1) Disconnect the vacuum hose from the vapor pressure sensor.
- (2) Using the MITYVAC (Hand-held Vacuum Pump), apply a vacuum of 4.0 kPa (30 mmHg, 1.18 in.Hg) to the vapor pressure sensor.

NOTICE:

The vacuum applied to the vapor pressure sensor must be less than 66.7 kPa (500 mmHg, 19.7 in.Hg).

OK:

- (1) **Voltage: 2.9 – 3.7 V**
- (2) **Voltage: 0.5 V or less**

OK

Go to step 14.

NG

13 Check for open and short in harness and connector between vapor pressure sensor and ECM (See page [IN-28](#)).

NG Repair or replace harness or connector.

OK

Replace vapor pressure sensor.

14 Check VSV for EVAP.

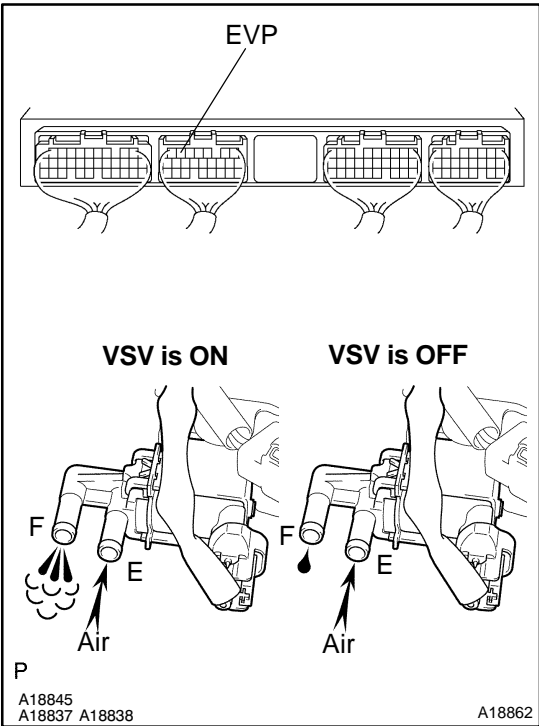

PREPARATION:
 (a) Remove the groove compartment (See page [SF-55](#)).
 (b) Turn the ignition switch ON.

CHECK:
 Check the VSV function.
 (1) Connect between terminal EVP1 of the ECM connector and body ground (ON).
 (2) Disconnect between terminal EVP1 of the ECM connector and body ground (OFF).

OK:
 (1) **VSV is ON:**
 Air from port E flows out through port F.
 (2) **VSV is OFF:**
 Air does not flow from port E to port F.

OK Go to step 17.

NG

15 Check operation of VSV for EVAP (See page [SF-43](#)).

NG Replace VSV for EVAP.

OK

- 16** Check for open and short in harness and connector between EFI main relay (Marking: EFI) and VSV for EVAP, and VSV for EVAP and ECM (See page [IN-28](#)).

NG

Repair or replace harness or connector.

OK

Check and replace ECM (See page [IN-28](#)).

- 17** Check VSV for CCV.

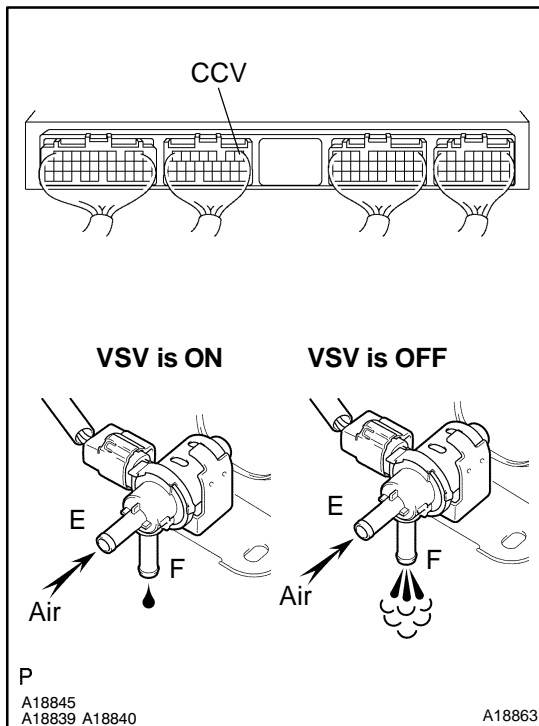
**PREPARATION:**

- Remove the grove compartment (See page [SF-55](#)).
- Turn the ignition switch ON.

CHECK:

Check the VSV function.

- Connect between terminal CCV of the ECM connector and body ground (ON).
- Disconnect between terminal CCV of the ECM connector and body ground (OFF).

OK:**VSV is ON:**

Air does not flow from port E to port F.

VSV is OFF:

Air from port E flows out through port F.

OK

Go to step 20.

NG

- 18** Check operation of VSV for CCV (See page [SF-44](#)).

NG

Replace VSV for CCV.

OK

19 Check for open and short in harness and connector between EFI main relay (Marking: EFI) and VSV for CCV, and VSV for CCV and ECM (See page [IN-28](#)).

NG Repair or replace harness or connector.

OK

Check and replace ECM (See page [IN-28](#)).

20 Check VSV for pressure switching valve.

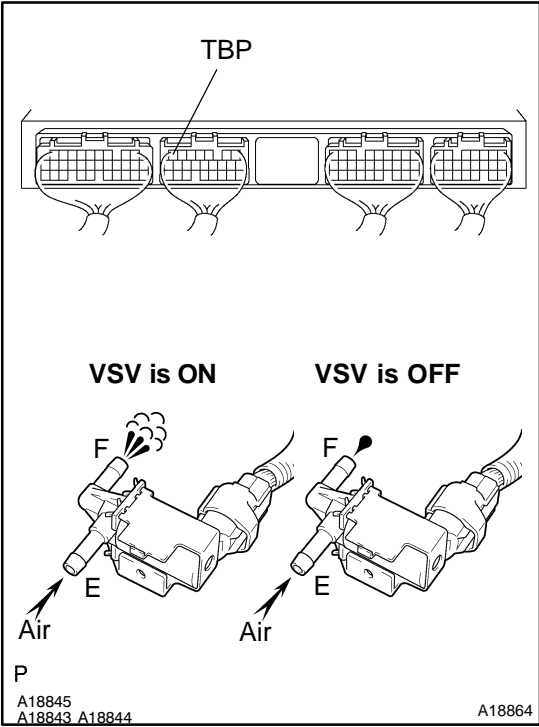

PREPARATION:
 (a) Remove the groove compartment (See page [SF-55](#)).
 (b) Turn the ignition switch ON.

CHECK:
 Check the VSV function.
 (1) Connect between terminal TBP of the ECM connector and body ground (ON).
 (2) Disconnect between terminal TBP of the ECM connector and body ground (OFF).

OK:
 (1) **VSV is ON:**
 Air from port E flows out through port F.
 (2) **VSV is OFF:**
 Air does not from flow port E to port F.

OK Go to step 23.

NG

21 Check operation of VSV for pressure switching valve (See page [SF-46](#)).

NG Replace VSV for pressure switching valve.

OK

22	Check for open and short in harness and connector between EFI main relay (Marking: EFI) and VSV for pressure switching valve, and VSV for pressure switching valve and ECM (See page IN-28).
----	---

NG → Repair or replace harness or connector.

OK

Check and replace ECM (See page [IN-28](#)).

23	Check the fuel tank over fill check valve (See page EC-8).
----	---

NG → Replace fuel tank over fill check valve.

OK

24	Check the fuel tank.
----	----------------------

NG → Replace fuel tank.

OK

It is likely that vehicle user did not properly close fuel tank cap. Please explain to customer how to properly install fuel tank cap.