

PRE-CHECK

1. DIAGNOSIS SYSTEM

(a) Description

- When troubleshooting OBD II vehicles, the only difference from the usual troubleshooting procedure is that you need to connect the vehicle to the OBD II scan tool complying with SAE J1978 or hand-held tester, and read off various data output from the vehicle's ECM.
- OBD II regulations require that the vehicle's on-board computer lights up the Malfunction Indicator Light (MIL) on the instrument panel when the computer detects a malfunction in the emission control system/components or in the powertrain control components which affect vehicle emissions, or a malfunction in the computer. In addition to the MIL lighting up when a malfunction is detected, the applicable Diagnostic Trouble Codes (DTCs) prescribed by SAE J2012 are recorded in the ECM memory (See page DI-16).

If the malfunction does not reoccur in 3 consecutive trips, the MIL goes off automatically but the DTCs remain recorded in the ECM memory.

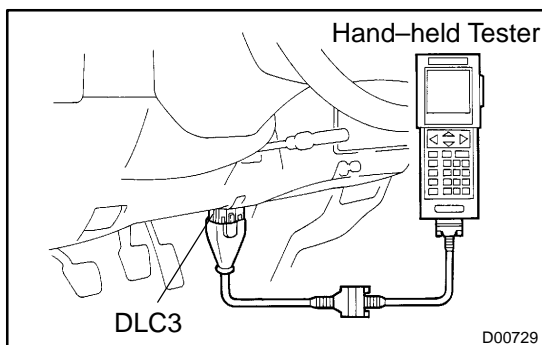
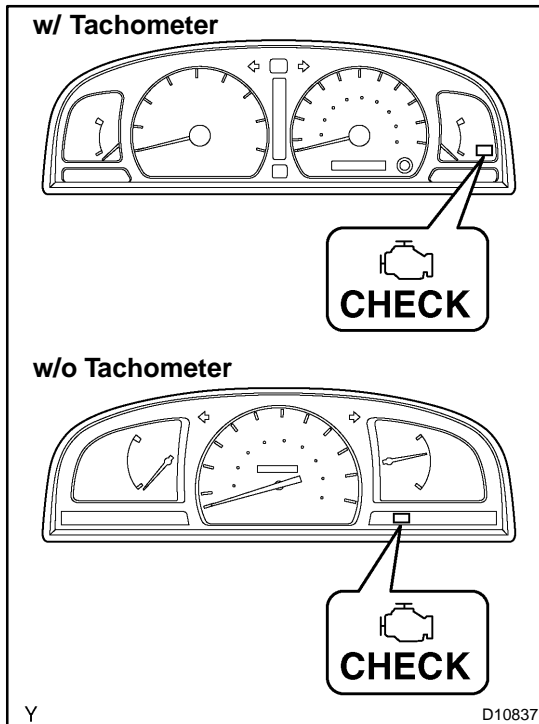

- To check the DTCs, connect the OBD II scan tool or hand-held tester to the Data Link Connector 3 (DLC3) on the vehicle. The OBD II scan tool or hand-held tester also enables you to erase the DTCs and check the freeze frame data and various forms of engine data (for operating instructions, see the OBD II scan tool's instruction book.). The DTCs include SAE controlled codes and manufacturer controlled codes. SAE controlled codes must be set as prescribed by the SAE, while manufacturer controlled codes can be set freely by a manufacturer within the prescribed limits (See DTC chart on page DI-16).

- The diagnosis system operates in the normal mode during normal vehicle use. It also has a check mode for technicians to simulate malfunction symptoms and troubleshoot. Most DTCs use 2 trip detection logic* to prevent an erroneous detection and ensure a thorough malfunction detections. By switching the ECM to the check mode when troubleshooting, a technician can cause the MIL to light up for a malfunction that is only detected once or momentarily (hand-held tester only) (See step 3).
- *2 trip detection logic:
When a malfunction is first detected, the malfunction is temporarily stored in the ECM memory (1st trip). If the same malfunction is detected again during the second drive test, this second detection causes the MIL to light up. (2nd trip) (however, the ignition switch must be turned OFF between the 1st trip and 2nd trip.)
- Freeze frame data:
The freeze frame data records the engine conditions (fuel system, calculated load, engine coolant temperature, fuel trim, engine speed, vehicle speed, etc.) when the malfunction is detected. When troubleshooting, it is useful for determining whether the vehicle was running or stopped, the engine was warmed up or not, the air-fuel ratio was lean or rich, etc. at the time of the malfunction.

Priorities for troubleshooting:

If troubleshooting priorities for multiple DTCs are given in the applicable DTC chart, these should be followed.

If no instructions are given, troubleshoot DTCs according to the following priorities.

- (1) DTCs other than fuel trim malfunction (DTCs P0171 and P0172), EGR (DTCs P0401 and P0402), and misfire (DTCs P0300 – P0304).
- (2) Fuel trim malfunction (DTCs P0171 and P0172), and EGR (DTCs P0401 and P0402).
- (3) Misfire (DTCs P0300 – P0304).

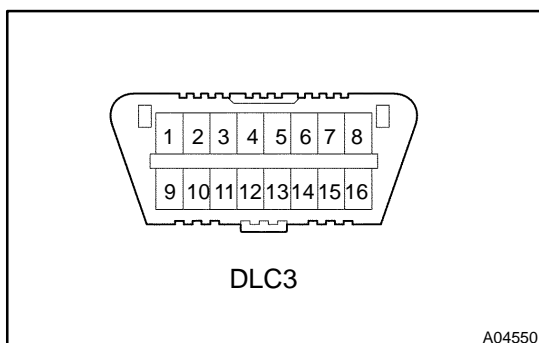

- (b) Check the DLC3.
The vehicle's ECM uses the ISO 9141-2 communication protocol. The terminal arrangement of the DLC3 complies with SAE J1962 and matches the ISO 9141-2 format.

Terminal No.	Connection/Voltage or Resistance	Condition
7	Bus (+) Line/Pulse generation	During transmission
4	Chassis Ground – Body Ground/1 Ω or less	Always
5	Signal Ground – Body Ground/1 Ω or less	Always
16	Battery Positive – Body Ground/9 – 14 V	Always

HINT:

If your display shows **UNABLE TO CONNECT TO VEHICLE** when you have connected the cable of the OBD II scan tool or hand-held tester to the DLC3, turned the ignition switch ON and operated the scan tool, there is a problem on the vehicle side or tool side.

- If the communication is normal when the tool is connected to another vehicle, inspect the DLC3 of the original vehicle.
- If the communication is still not possible when the tool is connected to another vehicle, the problem is probably in the tool itself, so consult the Service Department listed in the tool's instruction manual.

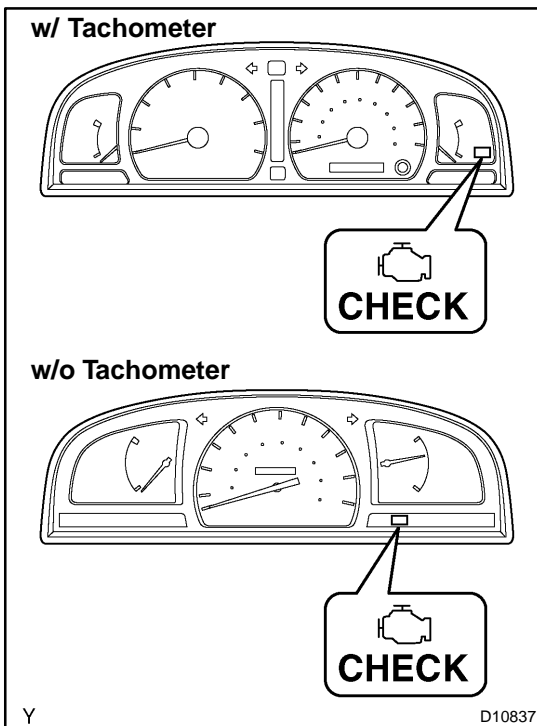
**2. Normal Mode:****INSPECT DIAGNOSIS**

- (a) Check the MIL.
- (1) The MIL comes on when the ignition switch is turned ON and the engine is not running.

HINT:

If the MIL does not light up, troubleshoot the combination meter (See page [BE-2](#)).

- (2) When the engine started, the MIL should go off. If the light remains on, the diagnosis system has detected a malfunction or abnormality in the system.

- (b) Check the DTC.

NOTICE:

- If there is no DTC in the normal mode, check the 1st trip DTC using the **Continuous Test Results** function (Mode 7 for SAE J1979) on the OBD II scan tool or hand-held tester.

- **Hand-held tester only:**

When the diagnosis system is switched from the normal mode to the check mode, all the DTCs and freeze frame data recorded in the normal mode will be erased. So before switching modes, always check the DTCs and freeze frame data, and note them down.

- (1) Prepare the OBD II scan tool (complying with SAE J1978) or hand-held tester.
- (2) Connect the OBD II scan tool or hand-held tester to the DLC3 at the lower left of the instrument panel.

- (3) Turn the ignition switch ON and turn the OBD II scan tool or hand-held tester switch ON.
- (4) Use the OBD II scan tool or hand-held tester to check the DTCs and freeze frame data and note them down (for operating instructions, see the OBD II scan tool's instruction book.).

If there is no DTC in the normal mode, check the 1st trip DTC using Continuous Test Results function (Mode 7 for SAE J1979) on the OBD II scan tool or hand-held tester.

- (5) See step 4. to confirm the details of the DTCs.

NOTICE:

- **When simulating a symptom with the OBD II scan tool (excluding hand-held tester) to check the DTCs, use the normal mode. For code on the DTC chart subject to "2 trip detection logic", perform either of the following actions.**
- **Turn the ignition switch OFF after the symptom is simulated the first time. Then repeat the simulation process again. When the problem has been simulated twice, the MIL lights up and the DTCs are recorded in the ECM.**
- **Check the 1st trip DTC using Mode 7 (Continuous Test Results) for SAE J1979.**

- (c) Clear the DTC.

The DTCs and freeze frame data will be erased by either action.

- Operating the OBD II scan tool (complying with SAE J1978) or hand-held tester to erase the codes (See the OBD II scan tool's instruction book for operating instructions.).
- Disconnecting the battery terminals or remove the EFI fuse more than 60 seconds.

NOTICE:

If the hand-held tester switches the ECM from the normal mode to the check mode or vice-versa, or if the ignition switch is turned from ON to ACC or OFF during the check mode, the DTCs and freeze frame data will be erased.

**3. Check Mode:
INSPECT DIAGNOSIS**

HINT:

Hand-held tester only:

Compared to the normal mode, the check mode has further sensitivity to detect malfunctions.

Furthermore, the same diagnostic items which are detected in the normal mode can also be detected in the check mode.

Check the DTC.

- (1) Initial conditions
 - Battery positive voltage 11 V or more
 - Throttle valve fully closed
 - Transmission in the P or N position

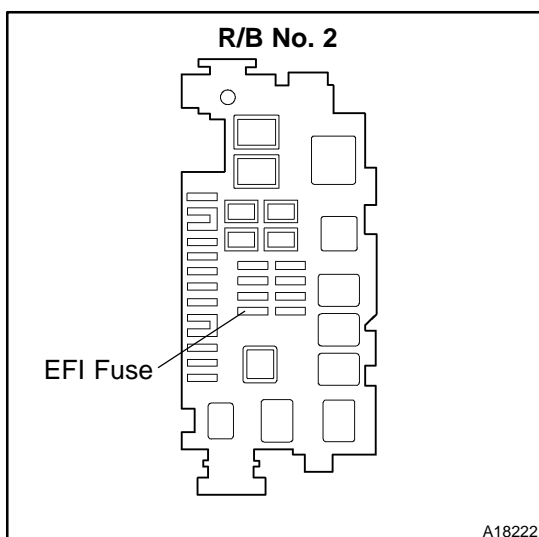

- A/C switched OFF
- (2) Turn the ignition switch OFF.
 - (3) Prepare the hand-held tester.
 - (4) Connect the hand-held tester to the DLC3 in the at the lower left of the instrument panel.
 - (5) Turn the ignition switch ON and push the hand-held tester ON.

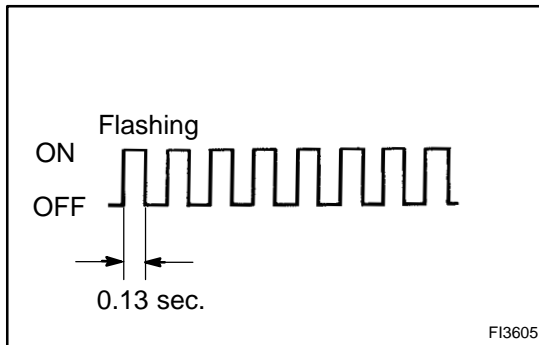

- (6) Switch the hand-held tester from the normal mode to the check mode (check that the MIL flashes).

NOTICE:

If the hand-held tester switches the ECM from the normal mode to the check mode or vice-versa, or if the ignition switch is turned from ON to ACC or OFF during the check mode, the DTCs and freeze frame data will be erased.

- (7) Start the engine (the MIL goes off after the engine starts).
- (8) Simulate the conditions of the malfunction described by the customer.

NOTICE:

Leave the ignition switch ON until you have checked the DTCs, etc.

- (9) After simulating the malfunction conditions, use the hand-held tester diagnosis selector to check the DTCs and freeze frame data, etc.

HINT:

Be careful not to turn the ignition switch OFF. Turning the ignition switch OFF switches the diagnosis system from the check mode to the normal mode, so all the DTCs, etc. are erased.

- (10) After checking the DTC, inspect the applicable circuit.

4. FAIL-SAFE CHART

If any of the following codes is recorded, the ECM enters fail-safe mode.

DTC No.	Fail-Safe Operation	Fail-Safe Deactivation Conditions
P0100	<ul style="list-style-type: none"> • Ignition timing is calculated from engine speed and throttle opening angle. • Injection time fixed <ul style="list-style-type: none"> Starting -----11.6 msec. CTP switch ON ----- 3.2 msec. CTP switch OFF ----- 6.0 msec. 	Returned to normal condition
P0110	Intake air temperature fixed at 20°C (68°F)	Returned to normal condition
P0115	Engine coolant temperature fixed at 80°C (176°F)	Returned to normal condition
P0120	VTA fixed at 0 %	The following condition must be repeated at least 2 times consecutively When closed throttle position switch is ON: VTA \geq 0.1 V and \leq 0.95 V
P0036	The heater circuit in which an abnormality is detected is turned off	Ignition switch OFF
P0325	Max. timing retardation	Ignition switch OFF
P0340	Fuel cut	Returned to normal condition
P0351 P0352 P0353 P0354	Fuel cut	Returned to normal condition

5. CHECK FOR INTERMITTENT PROBLEMS

HINT:

Hand-held tester only:

By putting the vehicle's ECM in the check mode, 1 trip detection logic is possible instead of 2 trip detection logic and sensitivity to detect open circuits is increased. This makes it easier to detect intermittent problems.

- (a) Clear the DTCs (See step 2).
- (b) Set the check mode (See step 3).
- (c) Perform a simulation test (See page [IN-18](#)).
- (d) Check the connector and terminal (See page [IN-28](#)).
- (e) Handle the connector (See page [IN-28](#)).

6. BASIC INSPECTION

When the malfunction code is not confirmed in the DTC check, troubleshooting should be performed in all the possible circuits considered as a cause of the problems. In many cases, by carrying out the basic engine check shown in the following flow chart, the location causing the problem can be found quickly and efficiently. Therefore, use this check is essential to the engine troubleshooting.

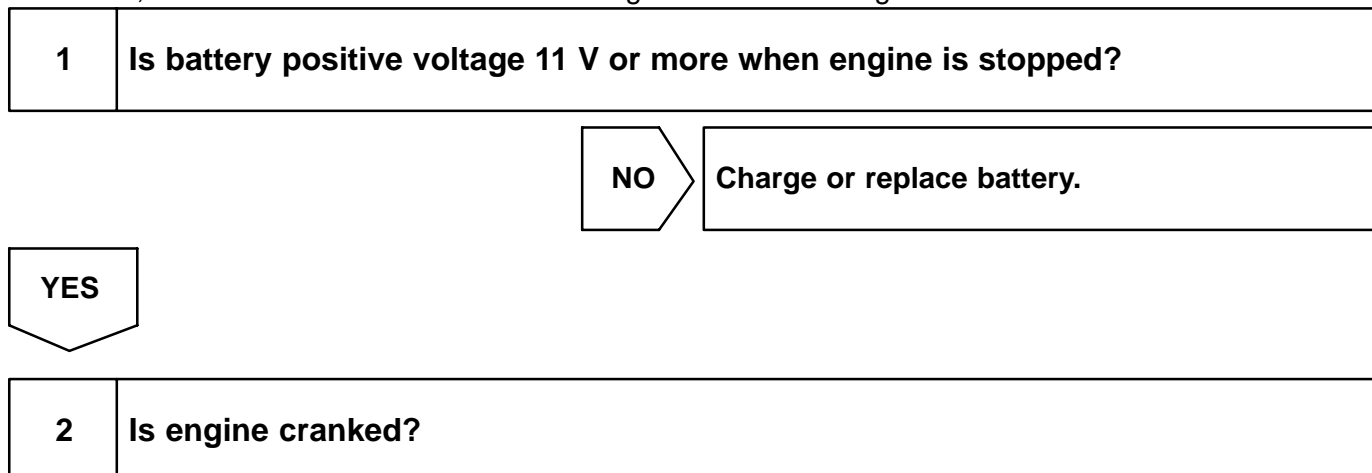

NO Proceed to pages **ST-16**, **ST-18**, and continue to troubleshoot.

YES

3 Does engine start?

NO Go to step 7.

YES

4 Check air filter.

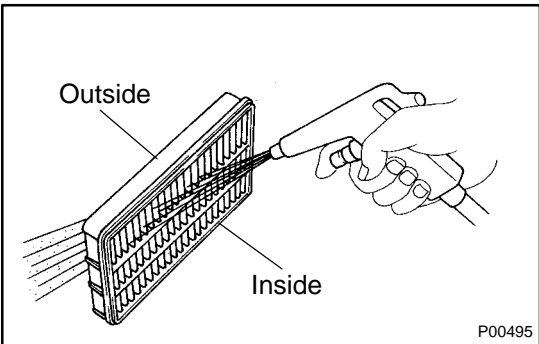

PREPARATION:
Remove the air filter.
CHECK:
Visually check that the air filter is not dirty nor excessive only.
HINT:
If necessary, clean the air filter with compressed air. First blow from inside thoroughly, then blow from outside of the air filter.

NG Repair or replace.

OK

5 Check idle speed.

PREPARATION:
(a) Warm up the engine to the normal operating temperature.
(b) Switch off all the accessories.
(c) Switch off the A/C.
(d) Shift the transmission into the N position.
(e) Connect the OBD II scan tool or hand-held tester to the DLC3 of the vehicle.
CHECK:
Use the "DIAGNOSIS/ENHANCED OBD II/DATA LIST/ALL" to check the idle speed.
OK:
Idle speed: 650 – 750 rpm

NG

Proceed to problem symptoms table on page [DI-24](#).

OK

6 Check ignition timing (See page [EM-10](#)).

NG

Proceed to page [IG-1](#), and continue to trouble-shoot.

OK

Proceed to problem symptoms table on page [DI-24](#).

7 Check fuel pressure.

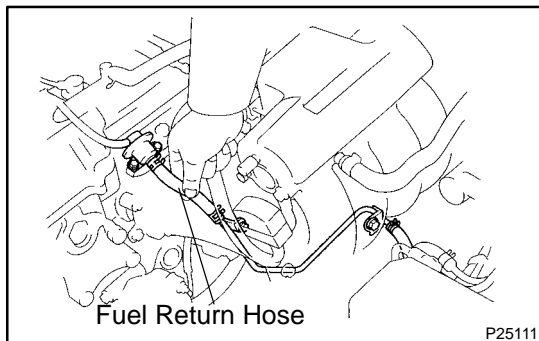
**PREPARATION:**

- (a) Be sure that the enough fuel is in the tank.
- (b) Connect the hand-held tester to the DLC3.
- (c) Turn the ignition switch ON and push the TOYOTA hand-held tester main switch ON.
- (d) Use the ACTIVE TEST mode to operate the fuel pump.
- (e) Please refer to the hand-held tester operator's manual for further details.
- (f) If you have no hand-held tester, connect the positive (+) and negative (-) leads from the battery to the fuel pump connector (See page [SF-5](#)).

CHECK:

Check for the fuel pressure in the fuel return hose when it is pinched by hand.

HINT:

At this time, you will hear the fuel flowing noise.

NG

Proceed to page [SF-5](#), and continue to trouble-shoot.

OK

8	Check for spark.
----------	-------------------------

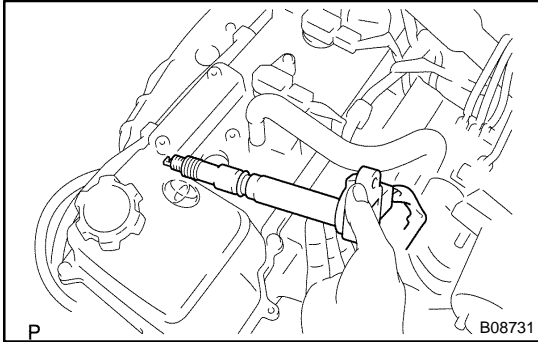
**PREPARATION:**

- (a) Remove the ignition coil.
- (b) Remove the spark plug.
- (c) Install the spark plug to the ignition coil, and connect the ignition coil connector.
- (d) Disconnect the injector connector.
- (e) Ground the spark plug.

CHECK:

Check if spark occurs while the engine is being cranked.

NOTICE:

To prevent excess fuel from being injected from the injectors during this test, don't crank the engine for more than 5 – 10 seconds at a time.

NG

Proceed to page IG-1 , and continue to troubleshoot.

OK

Proceed to problem symptoms table on page DI-24 .
--

7. DATA LIST

HINT:

According to the DATA LIST displayed by the OBD II scan tool or hand-held tester, you can read the value of the switch, sensor, actuator and so on without parts removal. Reading the DATA LIST as a first step of troubleshooting is one of the method to shorten the labor time.

NOTICE:

The values given below for "Normal Condition" are representative values. So a vehicle may still be normal even if its value differs from those listed here. So, do not depend solely on the "Normal Condition" here when deciding whether a part is faulty or not.

- (a) Warm up the engine.
- (b) Turn the ignition switch OFF.
- (c) Connect the OBD II scan tool or the Hand-held tester to the DLC3.
- (d) Turn the ignition switch ON.
- (e) According to the display on tester, read the "DATA LIST".

Hand-held tester display	Measurement Item	Normal Condition *	Diagnostic Note
INJECTOR	Injection period of the No. 1 cylinder/Min.: 0 ms, Max.: 32.64 ms	Idling: 2RZ-FE: 2.3 – 3.6 ms 3RZ-FE: 2.3 – 3.8 ms	
IGN ADVANCE	Ignition advance of ignition timing of No. 1 cylinder/Min.: –64 deg., Max.: 63.5 deg.	Idling: 2RZ-FE: BTDC 5 – 17° 3RZ-FE: BTDC 4 – 17°	
IAC DUTY RATIO	Duty ratio of the ISC valve/ Min.: 0 %, Max.: 99 %	Idling: 23 – 48 %	
CALC LOAD	Calculator load by ECM/ Min.: 0 %, Max.: 100 %	• Idling: 2RZ-FE: 12 – 22 % 3RZ-FE: 11 – 21 % • Racing without load (2,500 rpm): 2RZ-FE: 14 – 24 % 3RZ-FE: 12 – 22 %	
MAF	Air flow rate from MAF sensor/ Min.: 0 gm/s, Max.: 655 gm/s	• Idling: 2RZ-FE: 2.0 – 3.7 gm/sec. 3RZ-FE: 2.0 – 3.9 gm/sec. • Racing without load (2,500 rpm): 2RZ-FE: 8.3 – 14.3 gm/sec. 3RZ-FE: 8.0 – 14.7 gm/sec.	
ENGINE SPD	Engine speed/ Min.: 0 rpm, Max.: 16383 rpm	Idling: 650 – 750 rpm	
COOLANT TEMP	Coolant temperature/ Min.: –40 °C, Max.: 140 °C	After warming up: 80 – 95 °C (176 – 203 °F)	If the value is "–40 °C" or "140 °C", sensor circuit is open or shorted.
INTAKE AIR	Intake air temperature/ Min.: –40 °C, Max.: 140 °C	Equivalent to ambient temperature	
THROTTLE POS	Absolute throttle position sensor/ Min.: 0 %, Max.: 100 %	• Throttle fully closed: 7 – 11 % • Throttle fully open: 65 – 75 %	
CTP SW	Closed throttle position switch/ ON or OFF	• Throttle fully closed: ON • Throttle open: OFF	
VEHICLE SPD	Vehicle Speed/ Min.: 0 km/h, Max.: 255 km/h	Vehicle stopped: 0 km/h (0 mph)	
O2S B1 S2	Oxygen sensor output voltage of the bank 1 sensor 2/ Min.: 0 V, Max.: 1.275 V	Driving (50 km/h, 31 mph): 0.1 – 0.9 V	

DIAGNOSTICS – ENGINE (2RZ-FE, 3RZ-FE)

A/FS B1 S1	A/F sensor output voltage of the bank 1 sensor 1/ Min.: 0 V, Max.: 7.999 V	Idling: 2.8 – 3.8 V	
EGRT GAS (3RZ-FE)	EGR Gas Temperature/ Min.: 0 °C, Max.: 159.4 °C	Fuel tank cap removed: 0 kPa	
VAPOR PRESS VSV	Vapor Pressure/ Min.: -4.125 kPa, Max.: 2.125 kPa	VSV operating: ON (TANK)	
SHORT FT #1	Short term fuel trim of bank 1/ Min.: -100 %, Max.: 100%	0 ± 20 %	
LONG FT #1	Long term fuel trim of bank 1/ Min.: -100 %, Max.: 100 %	0 ± 20 %	
TOTAL FT #1	Total fuel trim of bank 1/ Min.: 0.5, Max.: 1.496	Idling: 0.8 – 1.2 V	
O2FT B1S2	Short term fuel trim associated with the bank 1, sensor 2/Min.: -100 %, Max.: 100%	0 ± 20 %	
A/F FT B1 S1	Short term fuel trim associated with the bank 1, sensor 1/Min.: -100 %, Max.: 100%	0 ± 20 %	
FUEL SYS #1	Fuel system status (Bank1) / OL or CL or OLDRIVE or OLFAULT or CLFAULT	Idling after warming up: CL	<ul style="list-style-type: none"> • OL: Open Loop—has not yet satisfied conditions to go closed loop. • CL: Closed Loop—using oxygen sensor(s) as feed back for fuel control. • OL DRIVE: Open loop due to driving conditions. (power enrichment, deceleration enrichment) • OL FAULT: Open loop due to detected system fault. • CL FAULT: Closed loop, but fault with at least one oxygen sensor may be using single oxygen sensor for fuel control.
FC IDL	Idle fuel cut / ON or OFF	Fuel cut operating: ON	
MIL	MIL status / ON or OFF	MIL ON: ON	
STARTER SIG	Starter signal / ON or OFF	Cranking: ON	
A/C SIG	A/C signal / ON or OFF	A/C ON: ON	
ELECT LOAD SIG	Electrical load signal/ ON or OFF	Defogger switch ON: ON	
STOP LIGHT SW	Stop light switch / ON or OFF	Stop light switch ON: ON	
PS OIL PRESS SW	Power steering signal / ON or OFF	Steering position is; center: OFF Except center: ON	
PS SIGNAL	Power steering signal/ ON or OFF	After engine start: OFF After steer the steering: ON	
A/C CUT SIG	A/C cut signal/ ON or OFF	A/C S/W OFF: ON	

EGR SYSTEM (*2)	EGR System status/ ON or OFF	When idling: OFF	
FUEL PUMP / SPD	Fuel pump / speed status / ON/H or OFF/M, L	Idling: ON	
EVAP VSV	VSV status for EVAP control / ON or OFF	Idling: Below 30 %	
IGNITION	Ignition counter/ Min.: 0, Max.: 400	0 – 400	
CYL#1, CYL#2, CYL#3, CYL#4	Misfire ratio of the cylinder 1 – 6/ Min.: 0 %, Max.: 50%	0 %	
FC TAU	Fuel Cut TAU: Fuel cut during very light load/ ON or OFF	Fuel cut operating: ON	

*: If no conditions are specifically stated for "Idling", it means the shift lever is at the N or P position, the A/C switch is OFF and all accessory switches are OFF.

8. ACTIVE TEST

HINT:

Performing the ACTIVE TEST using the OBD II scan tool or Hand-held tester allows the relay, VSV, actuator and so on to operate without parts removal. Performing the ACTIVE TEST as a first step of troubleshooting is one of the method to shorten the labor time.

It is possible to display the DATA LIST during the ACTIVE TEST.

- Warm up the engine.
- Turn the ignition switch OFF.
- Connect the OBD II scan tool or the Hand-held tester to the DLC3.
- Turn the ignition switch ON.
- According to the display on tester, read the "ACTIVE TEST".

Hand-held tester display	Test Details	Diagnostic Note
INJ VOL	[Test Details] Control the injection volume Min.: -12.5 %, Max.: 24.8 % [Vehicle Condition] Engine speed: 3000rpm or less.	
A/F CONTROL	[Test Details] Control the injection volume -12.5 ⇔ 25 % (Change the injection volume to -12.5 % or 25 %.) [Vehicle Condition] Engine speed: 3000 rpm or less.	The following procedure of A/F CONTROL enables that to check its output (show its graph indication) of A/F sensor and oxygen sensor. To display the graph indication, select O2S B1 S1 or A/F B1S1 and press button "4" after selecting "ACTIVE TEST/A/F CONTROL/USER DATA".
IAC DUTY RATIO (w/o ETCS)	[Test Details] Control the IAC duty ratio Min.: 0 %, Max.: 90 % [Vehicle Condition] Engine speed: Idling Battery voltage: 8.5 V or more	
EGR SYSTEM (*1)	[Test Details] Activate the VSV for canister control. ON or OFF	
A/C CUT SIG	[Test Details] Control the A/C cut signal ON or OFF	
CAN CTRL VSV	[Test Details] Activate the VSV for canister control. ON or OFF	

DIAGNOSTICS - ENGINE (2RZ-FE, 3RZ-FE)

TANK BYPASS VSV	[Test Details] Activate the VSV for tank bypass. ON or OFF	
EVAP VSV (ALONE)	[Test Details] Activate the VSV for EVAP control. ON or OFF	
FUEL PUMP / SPD	[Test Details] Control the fuel pump. ON or OFF	
TC/TE1	[Test Details] Connect the TC and TE1 ON or OFF	
FC IDL PROHBT	[Test Details] Control the idle fuel cut prohibit ON or OFF	

*1: Only for 3RZ-FE