

MANUAL TRANSMISSION UNIT (4WD) COMPONENTS

MT02U-01

w/o One Touch 2-4 Selector System:

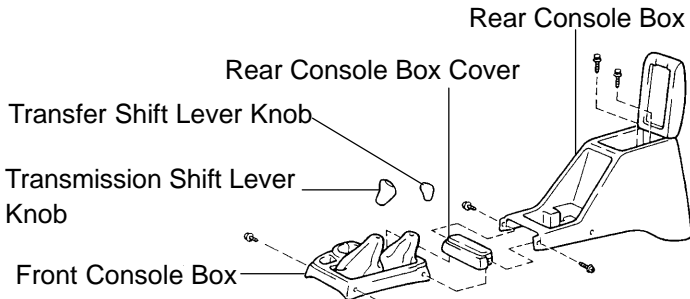

w/ One Touch 2-4 Selector System:

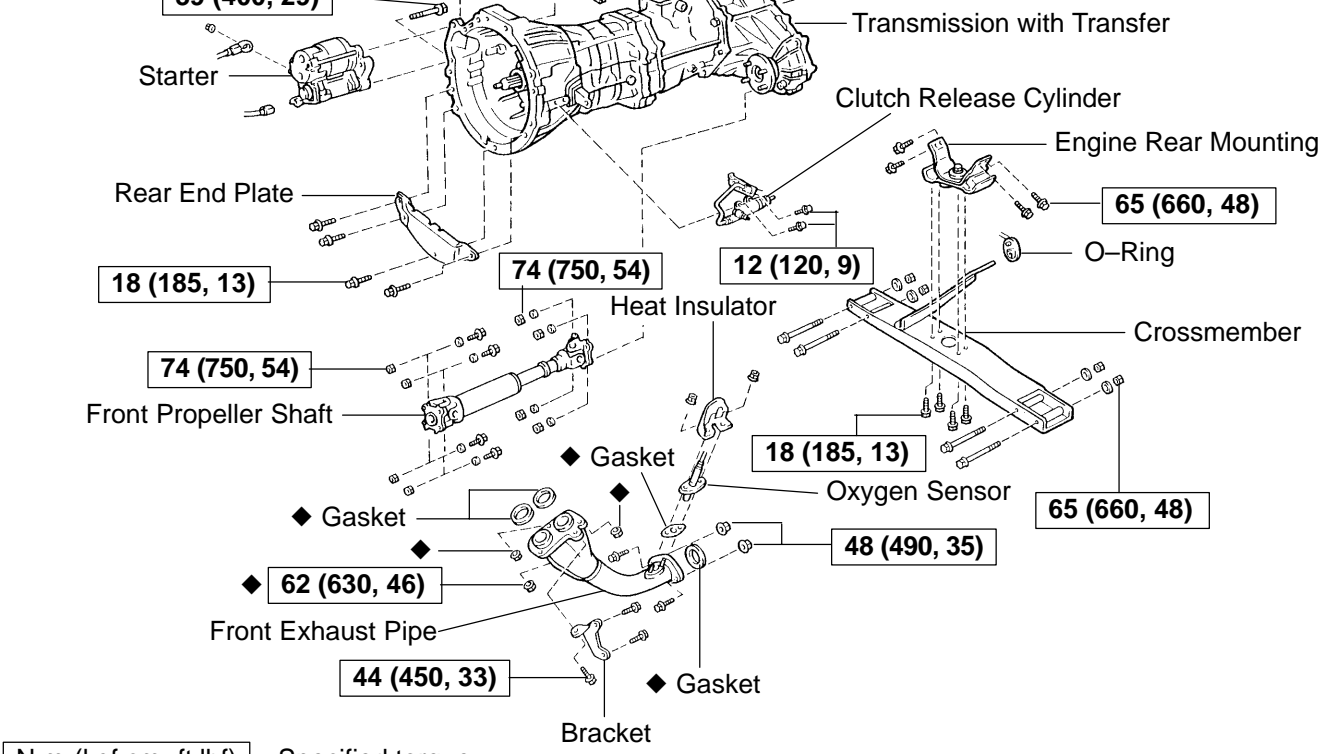
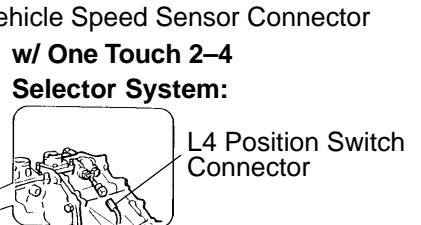
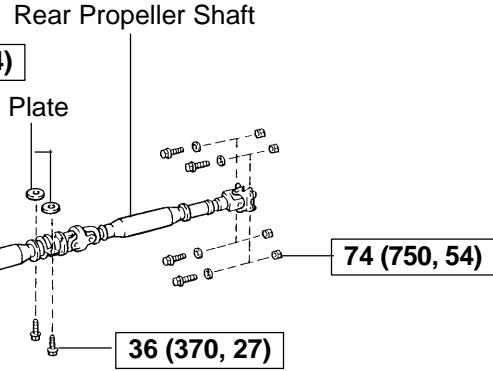
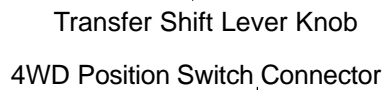
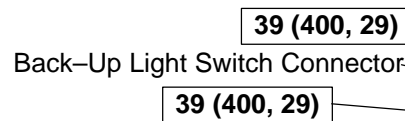
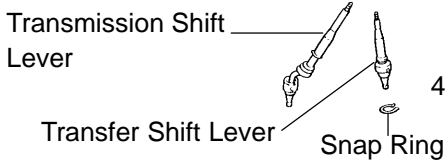
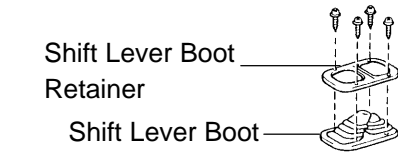

N·m (kgf·cm, ft·lbf) : Specified torque
◆ Non-reusable part

D00464